

PNOZ m B0



Configurable Control System PNOZmulti

This document is a translation of the original document.

All rights to this documentation are reserved by Pilz GmbH & Co. KG. Copies may be made for internal purposes.

Suggestions and comments for improving this documentation will be gratefully received.

Pilz[®], PIT[®], PMI[®], PNOZ[®], Primo[®], PSEN[®], PSS[®], PVIS[®], SafetyBUS p[®], SafetyEYE[®], SafetyNET p[®], the spirit of safety[®] are registered and protected trademarks of Pilz GmbH & Co. KG in some countries.



SD means Secure Digital.

Contents		Page
Chapter 1 Introduction		
1.1	Validity of documentation	1-1
1.1.1	Retaining the documentation	1-1
1.2	Overview of documentation	1-2
1.3	Definition of symbols	1-3
Chapter 2 Overview		
2.1	Unit structure	2-1
2.1.1	Range	2-1
2.1.2	Unit features	2-1
2.1.3	Chip card	2-2
2.2	Front view	2-3
Chapter 3 Safety		
3.1	Intended use	3-1
3.1.1	System requirements	3-1
3.2	Safety regulations	3-2
3.2.1	Use of qualified personnel	3-2
3.2.2	Warranty and liability	3-2
3.2.3	Disposal	3-2
3.2.4	For your safety	3-3
Chapter 4 Function description		
4.1	Device properties	4-1
4.1.1	Integrated protection mechanisms	4-1
4.1.2	Function description	4-1
4.1.2.1	Operation	4-1
4.1.2.2	System reaction time	4-1
4.1.2.3	Block diagram	4-2
4.1.2.4	Diagnostics	4-2
Chapter 5 Installation		
5.1	Install base unit without expansion module	5-1
5.2	Control cabinet installation	5-2
5.2.1	Dimensions	5-2
5.2.2	Mounting distances	5-3
5.3	Connecting the base unit and expansion modules	5-4
Chapter 6 Commissioning		
6.1	General wiring guidelines	6-1
6.2	Preparing for operation	6-2
6.2.1	Function test during commissioning	6-2

6.2.2	Commissioning the control system	6-2
6.2.2.1	Load project from chip card	6-3
6.2.2.2	Load project via USB port	6-3
6.2.3	Connection	6-4
6.2.4	Using the chip card	6-7
6.3	Connection example	6-8
Chapter 7 Operation		
7.1	Rotary knob	7-1
7.1.1	Function	7-1
7.1.2	Pull out and retract the knob	7-1
7.1.3	Rotate and press the knob	7-1
7.2	Messages	7-2
7.2.1	Display elements	7-2
7.2.1.1	Status indicators	7-2
7.2.1.2	Display	7-3
Chapter 8 Technical Details		
8.1	Technical details	8-1
8.2	Maximum capacitive load C (μF) with load current I (A) at the semiconductor outputs	8-4
8.3	Maximum permitted total current of the semiconductor outputs	8-5
8.4	Maximum permitted humidity	8-6
8.4.1	Max. relative humidity, operation	8-6
8.4.2	Max. relative humidity, storage	8-6
8.5	Order reference	8-7

1 Introduction

1.1 Validity of documentation

This documentation is valid for the product **PNOZ m B0**. It is valid until new documentation is published.

This operating manual explains the function and operation, describes the installation and provides guidelines on how to connect the product.

1.1.1 Retaining the documentation

This documentation is intended for instruction and should be retained for future reference.

1.2 Overview of documentation

1 Introduction

The introduction is designed to familiarise you with the contents, structure and specific order of this manual.

2 Overview

This chapter provides information on the product's most important features.

3 Safety

This chapter must be read as it contains important information on intended use.

4 Function Description

This chapter describes the product's mode of operation.

5 Installation

This chapter explains how to install the product.

6 Commissioning

This chapter describes the product's commissioning and wiring.

7 Operation

This chapter describes how to operate the product and gives tips in the case of a fault.

8 Technical Details

This chapter contains the product's technical details and order reference.

1.3 Definition of symbols

Information that is particularly important is identified as follows:



DANGER!

This warning must be heeded! It warns of a hazardous situation that poses an immediate threat of serious injury and death and indicates preventive measures that can be taken.



WARNING!

This warning must be heeded! It warns of a hazardous situation that could lead to serious injury and death and indicates preventive measures that can be taken.



CAUTION!

This refers to a hazard that can lead to a less serious or minor injury plus material damage, and also provides information on preventive measures that can be taken.



NOTICE

This describes a situation in which the unit(s) could be damaged and also provides information on preventive measures that can be taken. It also highlights areas within the text that are of particular importance.



INFORMATION

This gives advice on applications and provides information on special features.

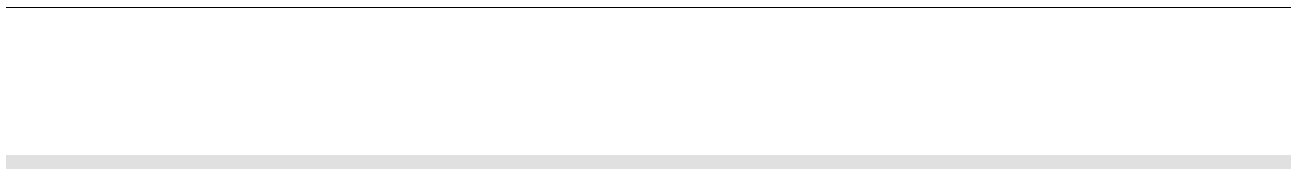

2.1 Unit structure

2.1.1 Range

- ▶ Base unit **PNOZ m B0**
- ▶ Terminator
- ▶ Documentation on data medium

2.1.2 Unit features

Using the product **PNOZ m B0**:

Base unit from the configurable control system PNOZmulti 2

The product has the following features:

- ▶ Can be configured in the PNOZmulti Configurator
- ▶ Semiconductor outputs:
 - 4 safety outputs
 - Depending on the application, up to PL e of EN ISO 13849-1 and up to SIL CL 3 of EN IEC 62061
- ▶ 12 inputs for connecting, for example:
 - Emergency stop pushbuttons
 - Two-hand pushbuttons
 - Safety gate limit switches
 - Reset buttons
 - Light beam devices
 - Scanners
 - Enabling switches
 - PSEN
 - Operating mode selector switches
- ▶ 8 configurable inputs/outputs
 - Can be configured as:
 - Inputs (see above for connection options)
 - or
 - Auxiliary outputs
- ▶ 4 configurable outputs
 - Can be configured as:
 - Auxiliary outputs
 - or
 - Test pulse outputs
- ▶ LED for:
 - Error messages
 - Diagnostics
 - Supply voltage
 - Fault at the outputs
 - Fault at the inputs

2.1 Unit structure

- ▶ Backlit display for:
 - Error messages
 - State of supply voltage
 - State of inputs/outputs
 - Status information
 - Device information
- ▶ Test pulse outputs used to monitor shorts across the inputs
- ▶ Monitoring of shorts between the safety outputs
- ▶ Plug-in connection terminals:
Either spring-loaded terminal or screw terminal available as an accessory (see order reference)
- ▶ Rotary knob for menu control
- ▶ Expansion modules can be connected
(please refer to the document "PNOZmulti System Expansion" for details of the type and number that can be connected)

2.1.3 Chip card

To be able to use the product you will need a chip card.

Chip cards are available with memories of 8 kByte and 32 kByte. For large-scale projects we recommend the 32 kByte chip card (see Technical Catalogue). Accessories chapter).

2.2 Front view

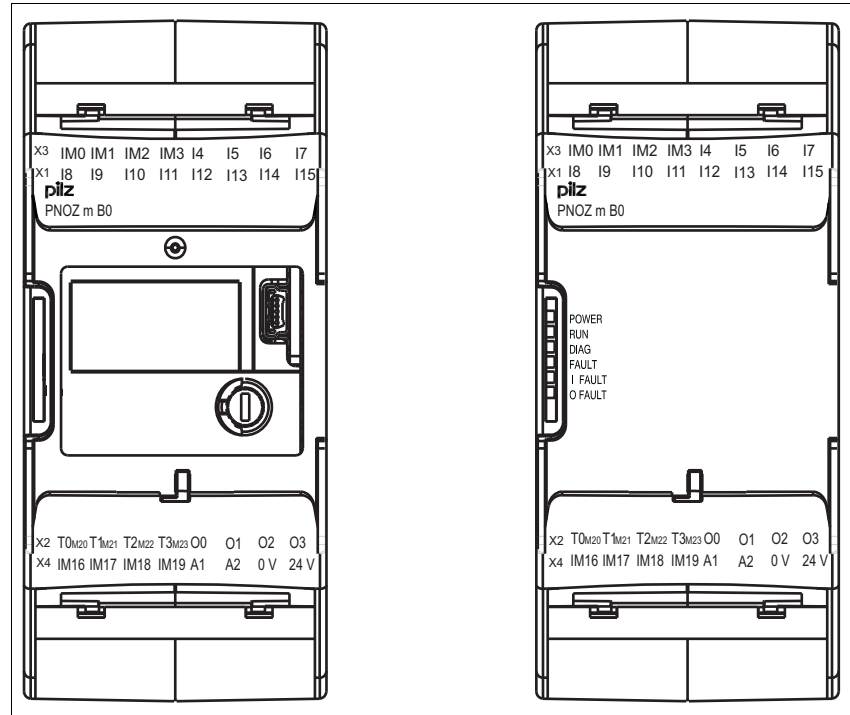

Front view with and without cover

Key

- ▶ X1:
 - Inputs I8 ... I15
- ▶ X2:
 - Configurable test pulse/auxiliary outputs TOM20 ... T3M23
 - Semiconductor outputs O0 ... O3
- ▶ X3:
 - Configurable inputs/outputs IM0 – IM3
 - Inputs I4 ... I7
- ▶ X4:
 - Configurable inputs/outputs IM16 – IM19
 - Supply connections
- ▶ LEDs:
 - POWER
 - RUN
 - DIAG
 - FAULT
 - I FAULT
 - O FAULT

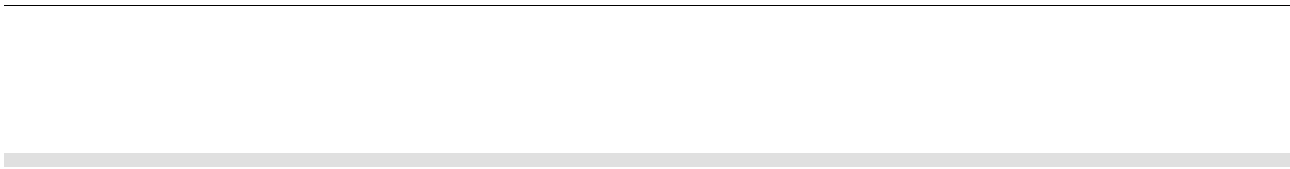

3.1 Intended use

The configurable control system PNOZmulti 2 is used for the safety-related interruption of safety circuits and is designed for use in:

- ▶ E-STOP equipment
- ▶ Safety circuits in accordance with VDE 0113 Part 1 and EN 60204-1



CAUTION!

Inputs and outputs for standard functions must not be used for safety-related applications.

Intended use includes making the electrical installation EMC-compliant. The product is designed for use in an industrial environment. It is not suitable for use in a domestic environment, as this can lead to interference.

The following is deemed improper use in particular:

- ▶ Any component, technical or electrical modification to the product
- ▶ Use of the product outside the areas described in this manual
- ▶ Use of the product outside the technical details (see chapter entitled "Technical Details")

3.1.1 System requirements

Please refer to the "Product Modifications" document in the "Version overview" section for details of which versions of the base unit and PNOZmulti Configurator can be used for this product.

3.2 Safety regulations

3.2.1 Use of qualified personnel

The products may only be assembled, installed, programmed, commissioned, operated, maintained and decommissioned by competent persons.

A competent person is someone who, because of their training, experience and current professional activity, has the specialist knowledge required to test, assess and operate the work equipment, devices, systems, plant and machinery in accordance with the general standards and guidelines for safety technology.

It is the company's responsibility only to employ personnel who:

- ▶ Are familiar with the basic regulations concerning health and safety / accident prevention
- ▶ Have read and understood the safety guidelines given in this description
- ▶ Have a good knowledge of the generic and specialist standards applicable to the specific application.

3.2.2 Warranty and liability

All claims to warranty and liability will be rendered invalid if:

- ▶ The product was used contrary to the purpose for which it is intended
- ▶ Damage can be attributed to not having followed the guidelines in the manual
- ▶ Operating personnel are not suitably qualified
- ▶ Any type of modification has been made (e.g. exchanging components on the PCB boards, soldering work etc.).

3.2.3 Disposal

- ▶ In safety-related applications, please comply with the mission time t_M in the safety-related characteristic data.
- ▶ When decommissioning, please comply with local regulations regarding the disposal of electronic devices (e.g. Electrical and Electronic Equipment Act).

3.2 Safety regulations

3.2.4 For your safety

The unit meets all the necessary conditions for safe operation. However, you should always ensure that the following safety requirements are met:

- ▶ Adequate protection must be provided for all inductive consumers.
- ▶ Do not open the housing or make any unauthorised modifications.
- ▶ Please make sure you shut down the supply voltage when performing maintenance work (e.g. exchanging contactors).

4.1 Device properties

4.1.1 Integrated protection mechanisms

The relay conforms to the following safety criteria:

- ▶ The circuit is redundant with built-in self-monitoring.
- ▶ The safety function remains effective in the case of a component failure.
- ▶ The safety outputs are tested periodically using a disconnection test.

4.1.2 Function description

4.1.2.1 Operation

The function of the inputs and outputs on the control system depends on the safety circuit created using the PNOZmulti Configurator. A chip card is used to download the safety circuit to the base unit. The base unit has 2 microcontrollers that monitor each other. They evaluate the input circuits on the base unit and expansion modules and switch the outputs on the base unit and expansion modules accordingly.

The LEDs on the base unit and expansion modules indicate the status of the configurable control system PNOZmulti.

The online help on the PNOZmulti Configurator contains descriptions of the operating modes and all the functions of the control system, plus connection examples.

4.1.2.2 System reaction time

The maximum reaction time between an input switching off and a linked semiconductor output in the system switching off is 39 ms. If other times are configured within the user program, switch-off may be delayed further.

4.1 Device properties

4.1.2.3 Block diagram

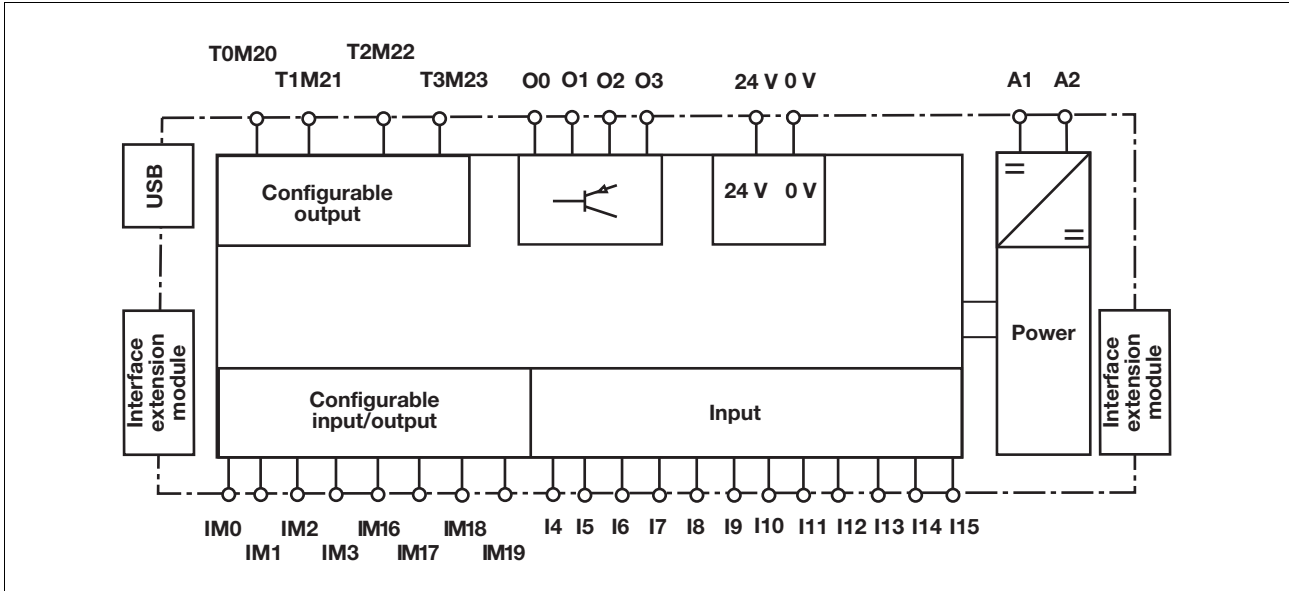

4.1.2.4 Diagnostics

The status and error messages displayed by the LEDs are saved in an error stack. This error stack can be shown on the display or can be read from the PNOZmulti Configurator via the USB port.

5.1 Install base unit without expansion module

Make sure that the terminators are inserted on the top left and right of the unit.

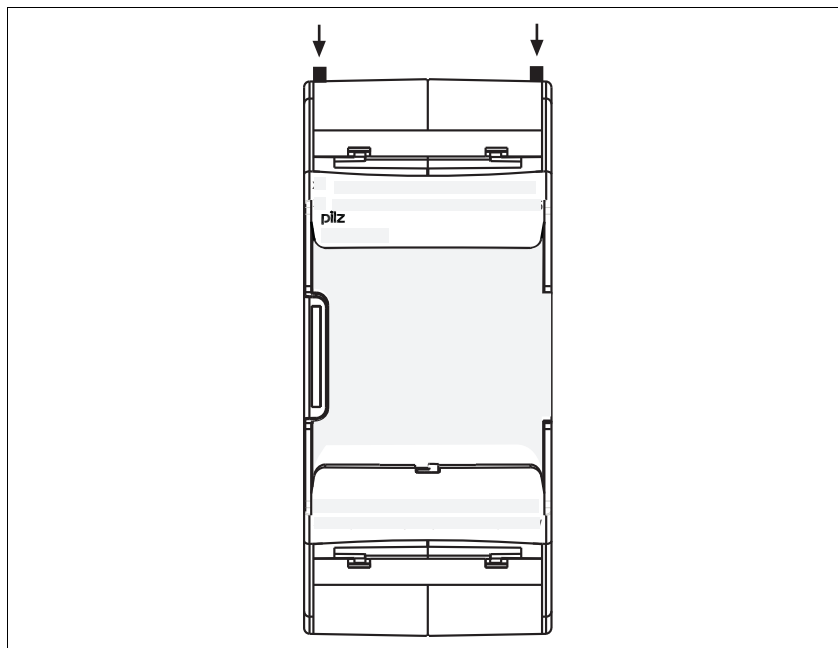

5.2 Control cabinet installation

- ▶ The unit should be installed in a control cabinet with a protection type of at least IP54.
- ▶ Fit the safety system to a horizontal mounting rail. The venting slots must face upward and downward. Other mounting positions could destroy the safety system.
- ▶ Use the locking slide on the rear of the unit to attach it to a mounting rail.
- ▶ In environments exposed to heavy vibration, the unit should be secured using a fixing element (e.g. retaining bracket or end angle).
- ▶ Open the locking slide before lifting the unit from the mounting rail.
- ▶ To comply with EMC requirements, the mounting rail must have a low impedance connection to the control cabinet housing.



CAUTION!

Damage due to electrostatic discharge!

Electrostatic discharge can damage components. Ensure against discharge before touching the product, e.g. by touching an earthed, conductive surface or by wearing an earthed arm-band.

5.2.1 Dimensions

*with spring-loaded terminals

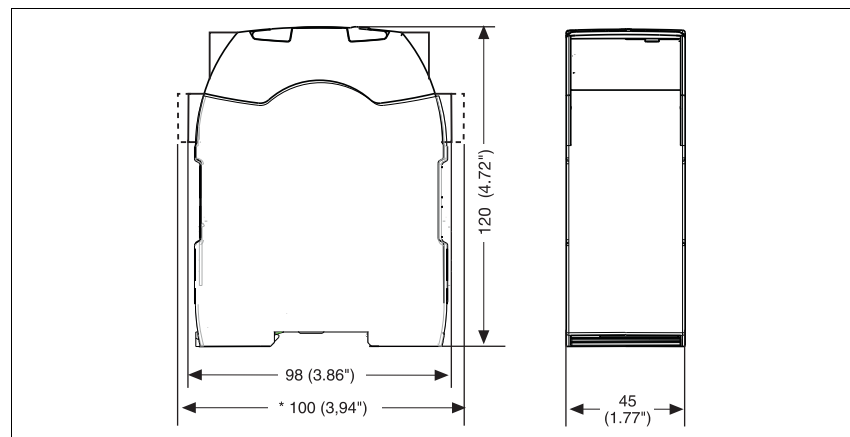

5.2 Control cabinet installation

5.2.2 Mounting distances

With control cabinet installation it is essential to maintain a certain distance from the top and bottom, as well as to other heat-producing devices (see diagram). The values stated for the mounting distances are minimum specifications.

The ambient temperature of the product in the control cabinet must not exceed the figure stated in the technical details, otherwise air conditioning will be required.

Mounting distances:

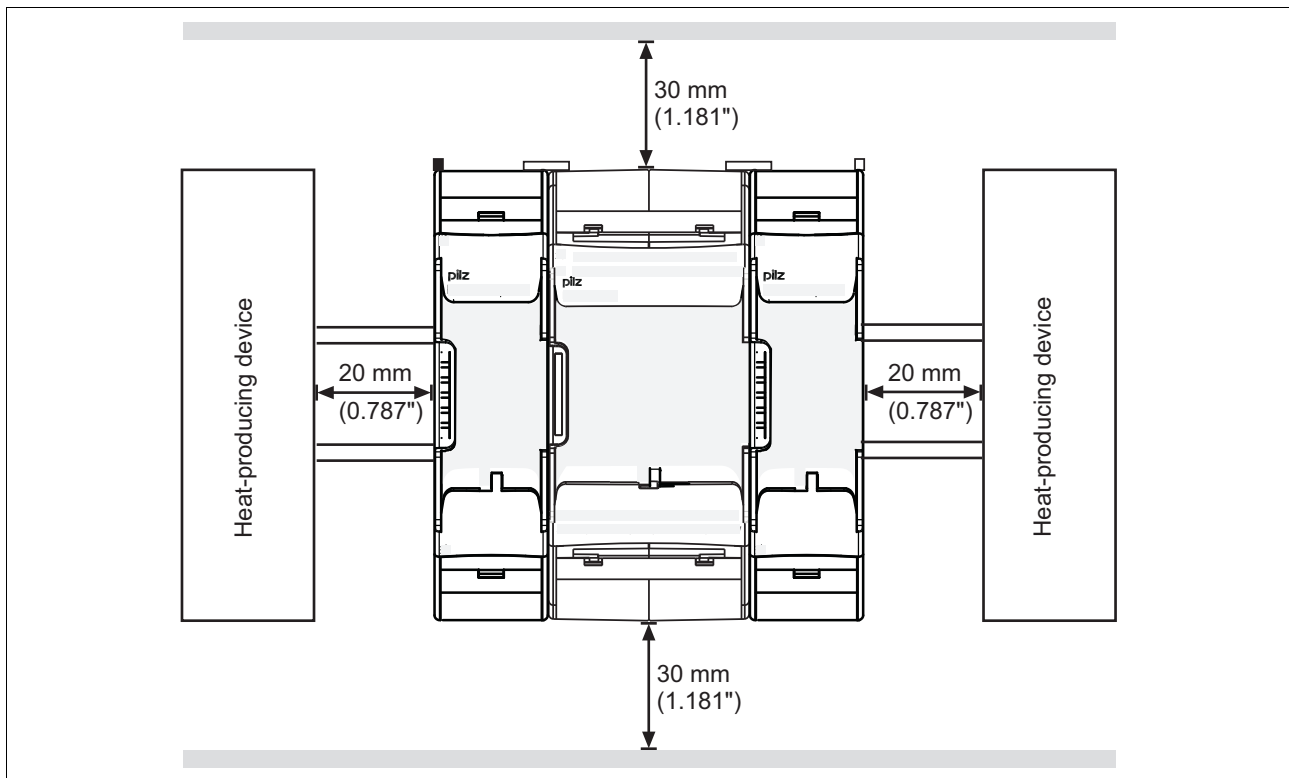

INFORMATION

Please note that at the stated minimum distance, it will be difficult to swap the chip card from above. If you cannot leave a greater distance, remove the unit from the mounting rail to swap the chip card.

5.3 Connecting the base unit and expansion modules

Please refer to the document "System Expansion" for details of the number of modules that can be connected to the base unit and the module types.

The modules are linked via jumpers.

- ▶ Remove the terminator on the side of the base unit and on the expansion module.
- ▶ Install the base unit and expansion modules on the mounting rail and connect the units using the jumper supplied
- ▶ Fit the terminator to the unconnected interfaces on the base unit and expansion module.

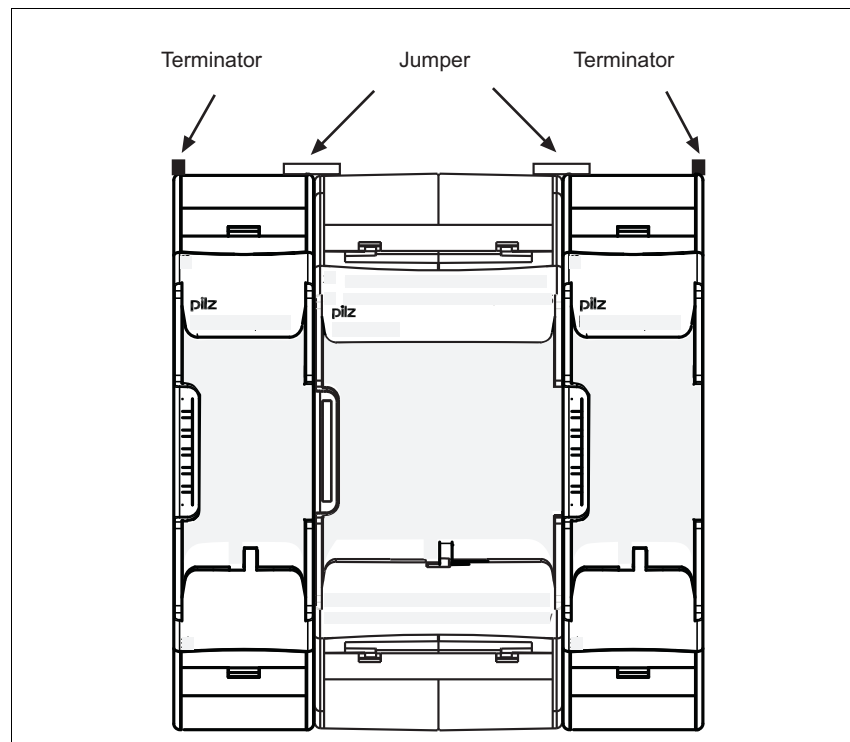
**CAUTION!**

Only connect the base unit and expansion modules when the supply voltage is switched off.

6.1 General wiring guidelines

The wiring is defined in the circuit diagram in the Configurator. There you can select the inputs that are to perform a safety function and the outputs that are to switch this safety function.

Note:

- ▶ Information given in the "Technical details" must be followed.
- ▶ Outputs O0 to O3 are semiconductor outputs
- ▶ Use copper wire that can withstand 75°C.
- ▶ Sufficient fuse protection must be provided on all output contacts with inductive loads.
- ▶ The safety system and input circuits must always be supplied by a single power supply. The power supply must meet the regulations for extra low voltages with safe separation.
- ▶ Test pulse outputs must exclusively be used to test the inputs. They must not be used to drive loads.

Do not route the test pulse lines together with actuator cables within an unprotected multicore cable.

6.2 Preparing for operation

6.2.1 Function test during commissioning



CAUTION!

It is essential to check that the safety devices operate correctly

- ▶ after the chip card has been exchanged
- ▶ after a project has been downloaded
- ▶ when the project has been deleted from the base unit's memory ("Reset Project" menu)

6.2.2 Commissioning the control system

Procedure:

- ▶ Wire the inputs and outputs on the base unit in accordance with the circuit diagram.
- ▶ Connect the supply voltage:
 - Supply voltage for the control system:
 - Terminal A1: + 24 VDC
 - Terminal A2: 0 V
 - Supply voltage for the semiconductor outputs:
 - 24 V terminal: + 24 VDC
 - 0V terminal: 0 V

Please note: The supply voltage for the semiconductor outputs must always be present, even if you are not using the semiconductor outputs.

When the voltages are fed separately using two power supplies, the supply voltage for the control system and the supply voltage for the semiconductor outputs are galvanically isolated.



CAUTION!

Do not connect or disconnect expansion modules and terminators during operation.

6.2 Preparing for operation

6.2.2.1 Load project from chip card

Procedure:

- ▶ Insert the chip card containing the current project into the card slot on the base unit.
- ▶ Switch on the supply voltage. The LC display shows the project name, CRC sum and the date the project was created. Please check this information.
- ▶ Load the project by pressing the rotary knob. For the project to be downloaded, the rotary knob must be held down for between 3 and 8 seconds. Once the project has been successfully downloaded, the status of the inputs and outputs will be shown on the display.

6.2.2.2 Load project via USB port

Procedure:

- ▶ Insert a chip card into the card slot on the base unit.
- ▶ Connect the computer containing the PNOZmulti Configurator to the base unit via the USB port.
- ▶ Switch on the supply voltage.
- ▶ Download the project (see PNOZmulti Configurator's online help).
- ▶ Once the project has been successfully downloaded, the status of the inputs and outputs and the supply voltage will be shown on the display. The "RUN" LED will be lit.

6.2 Preparing for operation

6.2.3 Connection

► Supply voltage

<p>Supply voltage</p> <p>Separate power supplies for the supply voltage to the control system and the supply voltage to the semiconductor outputs</p>	
<p>Common power supply for the supply voltage to the control system and the supply voltage to the semiconductor outputs</p>	

6.2 Preparing for operation

▶ Connection examples for the input circuit

Input circuit	Single-channel	Dual-channel
E-STOP without detection of shorts across contacts		
E-STOP with detection of shorts across contacts		

▶ Connection examples for reset circuit

Reset circuit	Input circuit without detection of shorts across contacts	Input circuit with detection of shorts across contacts

▶ Connection examples for semiconductor outputs

Redundant output		
Single output		
Single output with advanced fault detection*		

6.2 Preparing for operation

*Two loads may be connected to each safety output with advanced fault detection, even on applications in accordance with EN IEC 62061, SIL CL 3. Prerequisite: Feedback loop is connected, shorts across contacts and external power sources are excluded (e.g. through separate multi-core cables). Please note that, in the event of an error in the feedback loop, the safety system switches to a safe condition and shuts down **all** the outputs.

► Connection examples for feedback loop

Feedback loop	Redundant output
Contacts from external contactors	

6.2 Preparing for operation

6.2.4 Using the chip card



NOTICE

The chip card contact is only guaranteed if the contact surface is clean and undamaged. For this reason please protect the chip card's contact surface from

- ▶ Contamination
- ▶ Contact
- ▶ Mechanical impact, such as scratches.



NOTICE

Switch off the product before inserting or exchanging the chip card.

Make sure that you do not bend the chip card as you insert it into the chip card slot.

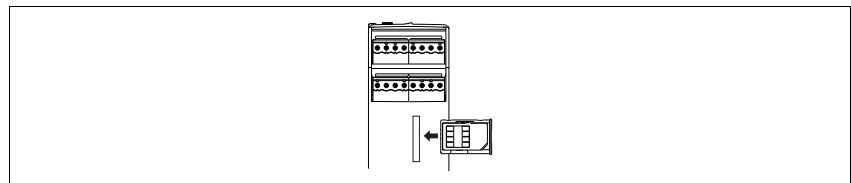

6.3 Connection example

Dual-channel E-STOP and safety gate wiring, monitored reset (IM18), feedback loop (IM16)

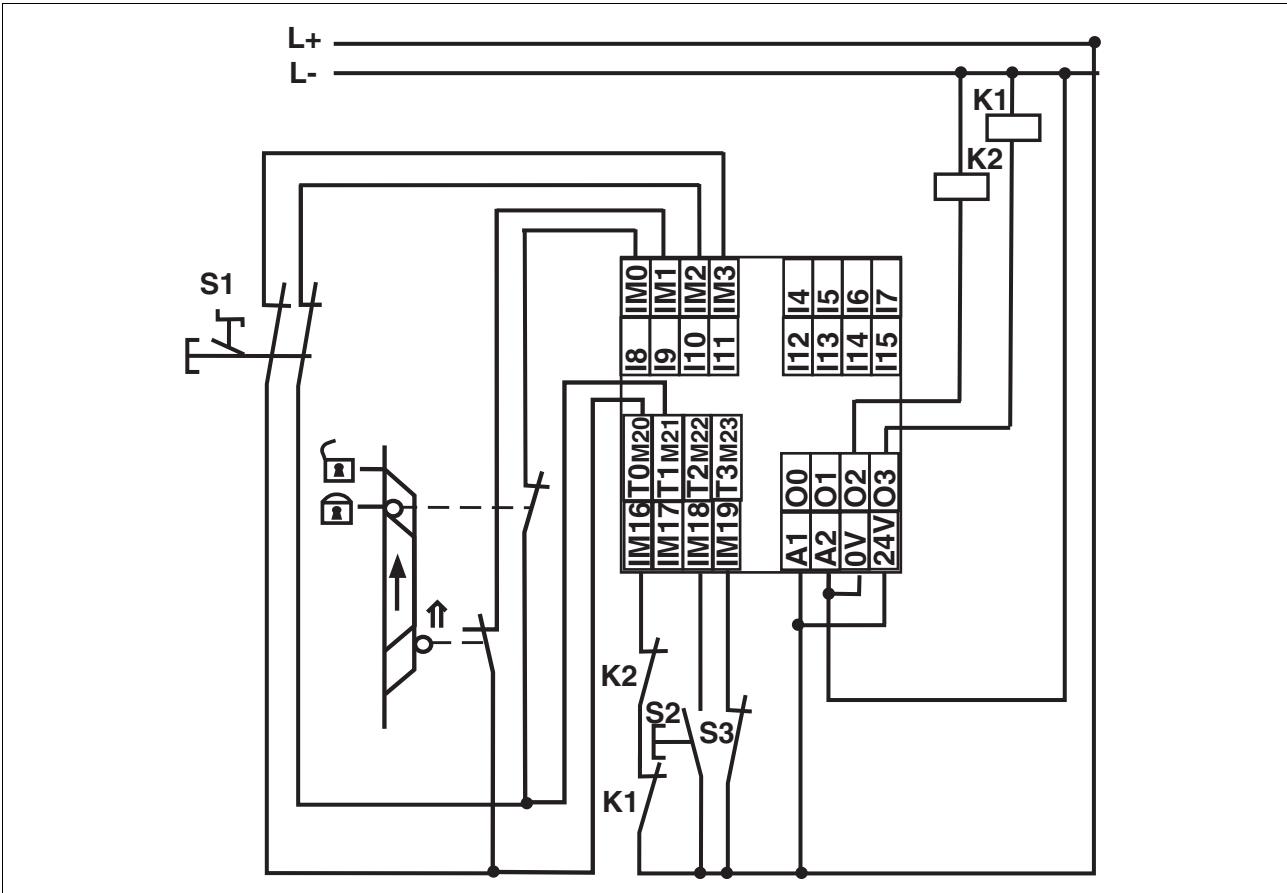

7.1 Rotary knob

7.1.1 Function

The menu settings are made on the unit's display via a rotary knob. You have the option to make the settings on the knob by hand or with a screwdriver. If you make the settings with a screwdriver, the knob can remain within the unit.

7.1.2 Pull out and retract the knob

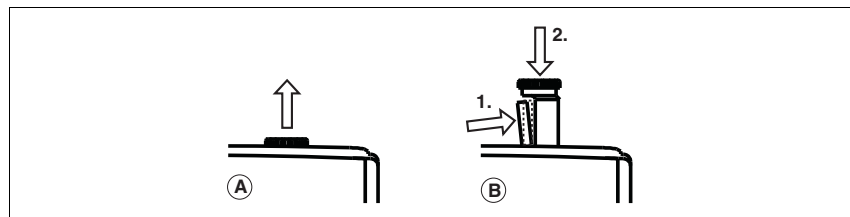

The rotary knob:

- ▶ (A) should be pulled out until it clicks into position
- ▶ (B) then released and retracted back into the unit:
 - Press the latch on the side of the rotary knob (1) towards the centre of the knob. This releases the rotary knob.
 - Press the knob downwards (2) while keeping the latch held down.

7.1.3 Rotate and press the knob



The settings are made via the rotary knob, as follows:

Press the knob

- ▶ Confirm selection/setting
- ▶ Switch to menu

Rotate knob

- ▶ Select menu level

7.2 Messages

The PNOZmulti control system is ready for operation when the "POWER" and "RUN" LEDs on the base unit are lit continuously.

7.2.1 Display elements

7.2.1.1 Status indicators

Legend:

	LED on
	LED flashes
	LED off

7.2.1.2 Display elements for device diagnostics

Basic					Fault
RUN	DIAG	FAULT	IFAULT	OFAULT	
●					The existing user program has been deleted.
●					External error on the base unit, leading to a safe condition, e.g. chip card not inserted
●					External error on the base unit outputs, e.g. short across the contacts, leading to a safe condition.
●					Internal error on the base unit
●					Internal error on the base unit (inputs)
●					Internal error on the base unit (outputs)
					Base unit in a STOP condition
					External error on the base unit inputs, which does not lead to a safe condition, e.g. partially operated
					External error on the outputs of the base unit, which does not lead to a safe condition, e.g. feedback input defective.
					The fieldbus module has not been recognised. or The base unit was identified by the PNOZmulti Configurator via the Ethernet interface. or An existing fieldbus connection was interrupted.



7.2 Messages

7.2.1.3 Display

The LC display has four lines. It displays information and navigates the menu:

Display	Example	Description
RUN State of inputs/outputs and supply voltage		The lines are assigned terminals X1 ... X4 State: ■ Input active □ Input inactive ◆ Semiconductor output active ◇ Semiconductor output inactive T Test pulse output Display in the event of a message (bottom M Message is present E Error message is present
ERROR Status and error messages		Line 1 ... 4: Status and error messages as short text.
DISPLAY MESSAGE Display messages		Line 1 ... 4: Customised messages that are created in the PNOZmulti Configurator.
PROJECT INFO Project information		Line 1: Project name Line 2: Project name Line 3: Check sum (CRC) Line 4: Creation date
SHOW DEVICE INFO? Show device information		Show device information for the base unit and expansion modules
DEVICE INFO Device information for the base unit and expansion modules		Line 1: Module position (Pos) Line 2: Product type Line 3: Device version (Version) Line 4: Firmware version (Firmw.)
SHOW ERROR STACK Show error stack		Shows the error stack entries

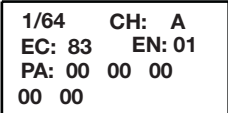
7.2 Messages

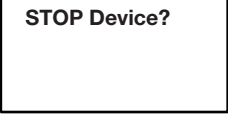
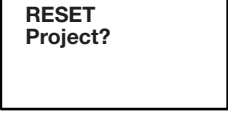
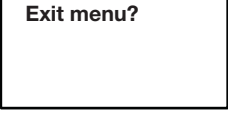
Display	Example	Description
ERROR STACK Error stack entries		Line 1: Sequential number Line 2: Error class (EC) and error information (EI) Line 3: Error number (EN) and error parameter (PA) Line 4: Continuation of error parameter (PA)
IP ADDRESS IP address of base unit (only appears on base units to which a communication module with Ethernet interface is connected)		Line 2 and 3: IP address
INTERFACE Interface (only appears on base units to which a communication module is connected)		Show selected interface / on expandable base units: Select interface
STOP Device? Stop device		Bring device to a STOP condition
RESET PROJECT? Delete project		Delete project from the base unit's memory
EXIT MENU? Exit menu		Exit menu

You can switch between the menu levels by pressing or rotating the knob.

7.2 Messages

7.2.1.4 Switch between menu levels

Schematic representation of the menu functions

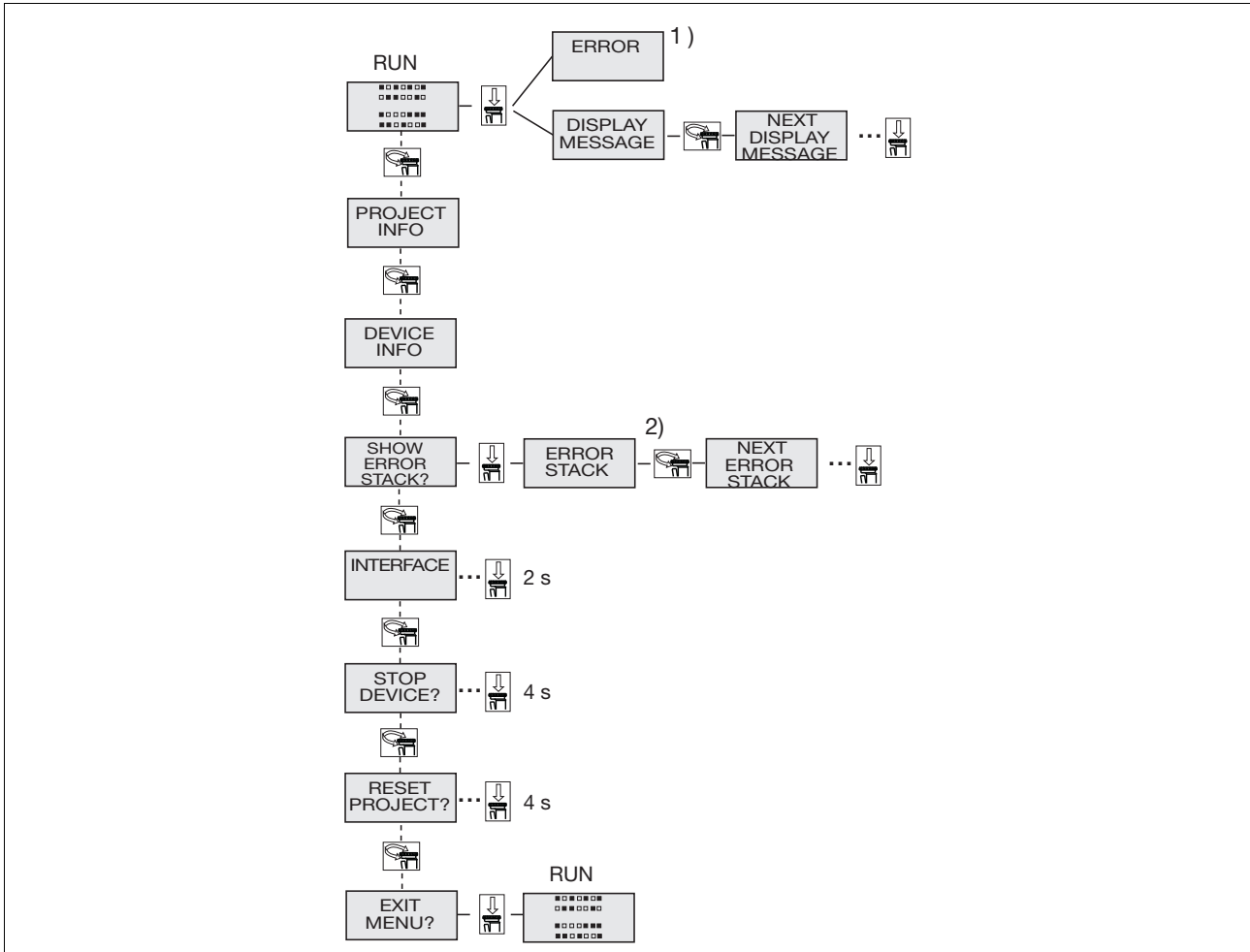

1) Further information on error messages can be found under "Unit diagnostics on the LC display"

2) Further information on the error stack can be found under "Error stack on the LC display"

7.2 Messages

7.2.1.5 Unit diagnostics on the LC display

Procedure for showing error messages on the LC display, when the errors do not lead to a safe condition:

- ▶ Use the rotary knob to display stored errors:

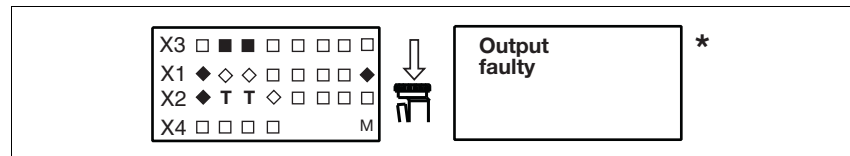

* If an error leads to a safe condition, the error message appears on the display immediately. Once the cause has been rectified, you will need to reset the unit

Procedure for resetting the unit:

- ▶ Press the rotary knob for between 3 and 8 seconds to reset the unit.

Error messages	Fault
FAULTY PROJECT	Chip card contains a project which is faulty or incompatible.
CHIP CARD ?	Chip card is not inserted, blank or unreadable
FAULTY TEST PULSE	Error caused by test pulse
PARTIALLY OPERATED	Function element was or is partially operated
FEED BACK LOOP	External error at the feedback loop inputs
OPERATING MODE SWITCH SELECTOR	Error on the operating mode selector switch function element
FAULTY OUTPUT	External error on the output
OUTPUT WITH ADVANCED FAULT DETECTION	External error on the output with advanced fault detection
LOAD SUPPLY	Error in the supply voltage for the semiconductor outputs
FAULTY DEVICE	Internal error on the base unit
SUPPLY LOW	Supply voltage is below the tolerance level
SUPPLY HIGH	Supply voltage exceeds the tolerance level
CONFIGURATION	Hardware registry does not match the configuration
TEMPERATURE	Operating temperature is outside the permitted range

7.2 Messages

7.2.1.6 Error stack on the LC display

The error stack can be read from the PNOZmulti Configurator or shown on the LC display. The error stack helps Pilz technical support with fault diagnostics. The error stack can store up to 64 status and error messages.

The following information is shown on the LC display:

- ▶ Sequential number of an error stack entry. A new error stack entry is stored in first place.
- ▶ Error class (EC) and error information (EI)
- ▶ Error number (EN) and five error parameters (PA)

Procedure for displaying the error stack on the LC display:

- ▶ Use the rotary knob to display the error stack.

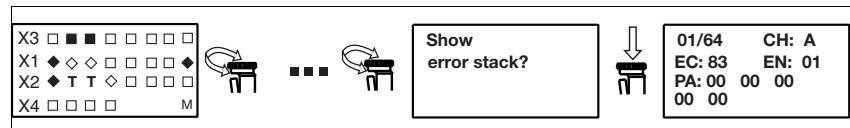

INFORMATION

Use the rotary knob to exit the error stack.

Procedure for reading the error stack with the PNOZmulti Configurator:

- ▶ See online help for the PNOZmulti Configurator

8.1 Technical details

Technical details	
Electrical data	
Infeed for	Supply to the system
Supply voltage	24 VDC
Voltage tolerance	-20 %/+25 %
Max. continuous current that the external power supply must provide	1.6 A
Max. inrush current that the external power supply must provide	3.0 A
Module's current consumption	32 mA
Module's power consumption	0.8 W
Infeed for	Supply to the SC outputs
Supply voltage	24 VDC
Voltage tolerance	-20 %/+25 %
Max. continuous current that the external power supply must provide	8.0 A
Potential isolation from system voltage	yes
Type of potential isolation	Basic insulation
Rated surge voltage	2500 V
Max. power dissipation of the module	7.40 W
Inputs	
Number	12
Potential isolation from system voltage	no
Input voltage in accordance with EN 61131-2 type 1	24 V DC
Input current at rated voltage	5 mA
Input current range	2.5 - 5.3 mA
Pulse suppression	0.5 ms
Maximum input delay	2 ms
Test pulse outputs	
Number of test pulse outputs	4
Potential isolation from system voltage	no
Voltage	24 V
Current	0.1 A
Short circuit-proof	yes
Semiconductor outputs	
Number of positive-switching single-pole semiconductor outputs	4
Potential isolation from system voltage	yes
Type of potential isolation	Basic insulation
Rated surge voltage	2,500 V
Voltage	24 V DC
Output current	2.00 A
Output current range	0.00 - 2.50 A
Max. transient pulsed current	12 A
Short circuit-proof	yes
Residual current (I_r)	0.05 mA
Max. internal voltage drop	500 mV
Max. duration of off time during self test	330 μs
Permitted loads	inductive, capacitive, resistive
Max. capacitive load	1 μF

8.1 Technical details

Configurable inputs/outputs (inputs or auxiliary outputs)	
Number	8
Potential isolation from system voltage	no
Inputs	
Input voltage in accordance with EN 61131-2 Type 1	24.0 V
Input current at rated voltage	5 mA
Input current range	2.5 - 5.3 mA
Maximum input delay	2.0 ms
Pulse suppression	0.5 ms
Auxiliary outputs	
Voltage	24.0 V
Output current	75 mA
Output current range	0 - 100 mA
Max. transient pulsed current	500 mA
Short circuit-proof	yes
Residual current at "0"	0.5 mA
Voltage at "1"	U_B - 2 V at 0,1 A
Environmental data	
Ambient temperature	0 - 60 °C
Forced convection off in control cabinet	55 °C
Storage temperature	-25 - 70 °C
Climatic suitability in accordance with standard	EN 60068-2-30, EN 60068-2-78
Condensation	not permitted
Max. operating height above sea level	< 2000 m
EMC	EN 61131-2
Vibration to EN 60068-2-6	
Frequency	5.0 - 150.0 Hz
Max. acceleration	1g
Airgap creepage in accordance with EN 61131-2	
Overvoltage category	II
Pollution degree	2
Rated insulation voltage	30 V
Shock stress	
EN 60068-2-27	15g
	11 ms
Mechanical data	
Protection type	
Mounting (e.g. cabinet)	IP54
Housing	IP20
Terminals	IP20
DIN rail	
Top hat rail	35 x 7.5 EN 50022
Recess width	27 mm
Maximum cable runs	
Max. cable length per input	1.0 km
Sum of individual cable runs at the test pulse output	2 km
Housing material	
Housing	PC
Front	PC

8.1 Technical details

Mechanical data	
Cross section of external conductors with screw terminals	
Power supply, inputs, configurable inputs/outputs, semi-conductor outputs, test pulse outputs:	
1 core flexible	0.25 - 2.50 mm ² , 24 - 12 AWG
2 core, same cross section, flexible:	
without crimp connectors or with TWIN crimp connectors	0.20 - 1.50 mm ² , 24 - 16 AWG
Torque setting with screw terminals	0.50 Nm
Cross section of external conductors with spring-loaded terminals: Flexible with/without crimp connectors	
Spring-loaded terminals: Terminal points per connection	2
Stripping length	9 mm
Dimensions	
Height	101.4 mm
Width	45.0 mm
Depth	120.0 mm
Weight	235 g

Safety characteristic data						
Unit	Operating mode	EN ISO 13849-1: 2006 PL	EN 954-1 Category	EN IEC 62061 SIL CL	PFH [1/h]	EN ISO 13849-1: 2006 T _M [year]

Logic						
CPU		PL e (Cat. 4)	Cat. 4	SIL CL 3	4.74E-10	20
Expansion left		PL e (Cat. 4)	Cat. 4	SIL CL 3	3.30E-11	20
Expansion right		PL e (Cat. 4)	Cat. 4	SIL CL 3	2.79E-11	20
Input						
SC inputs	single-channel	PL d (Cat. 2)	Cat. 3	SIL CL 2	3.85E-09	20
SC inputs	dual-channel	PL e (Cat. 4)	Cat. 4	SIL CL 3	7.95E-11	20
SC inputs	light beam device	PL e (Cat. 4)	Cat. 4	SIL CL 3	3.85E-10	20
Output						
SC outputs	single-channel with advanced fault detection	PL e (Cat. 4)	Cat. 4	SIL CL 3	1.66E-11	20
SC outputs	single-channel	PL d (Cat. 2)	Cat. 3	SIL CL 2	1.57E-10	20
SC outputs	dual-channel	PL e (Cat. 4)	Cat. 4	SIL CL 3	1.29E-10	20

All the units used within a safety function must be considered when calculating the safety characteristic data.

The standards current on **2012-04** apply.

8.2 Maximum capacitive load C (mF) with load current I (A) at the semiconductor outputs

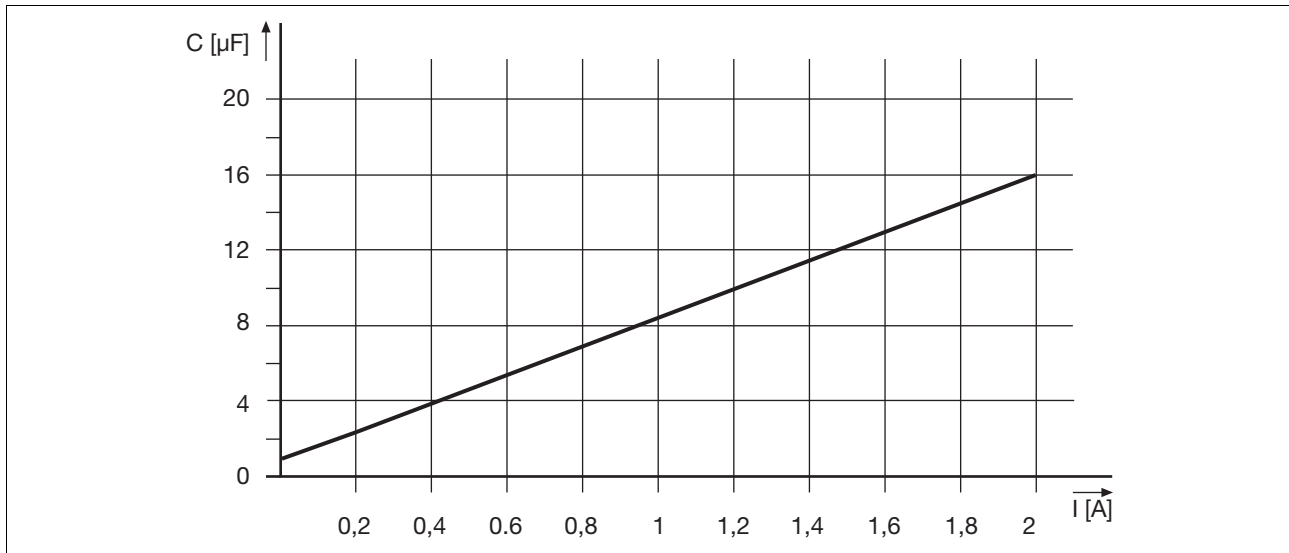

8.3 Maximum permitted total current of the semiconductor outputs

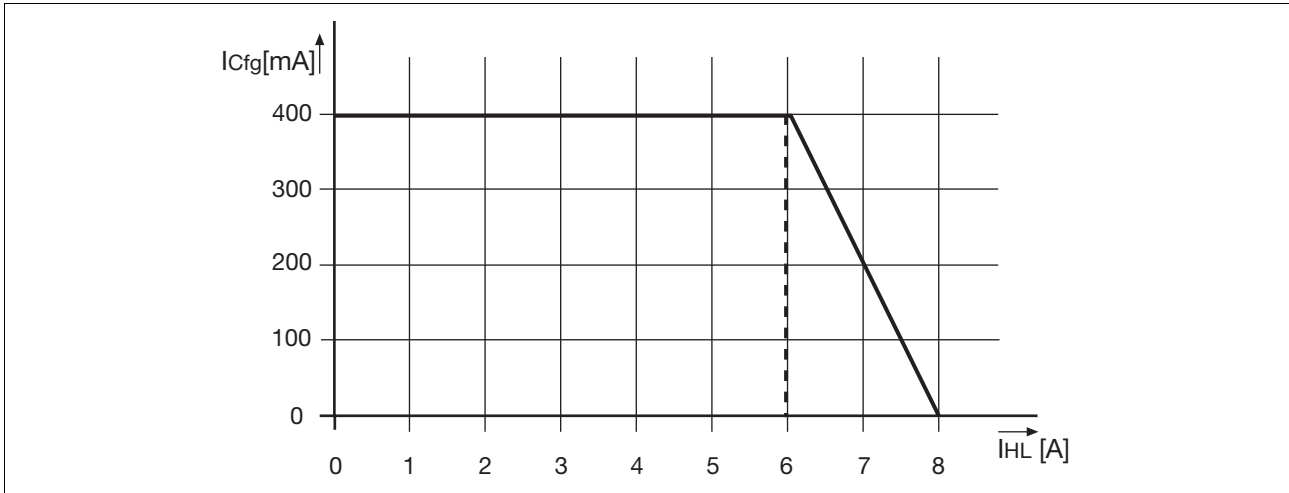

I_{Cfg} : Total current of the configurable semiconductor outputs (auxiliary outputs)

I_{HL} : Total current: Semiconductor outputs (safety outputs)

8.4 Maximum permitted humidity

8.4.1 Max. relative humidity, operation

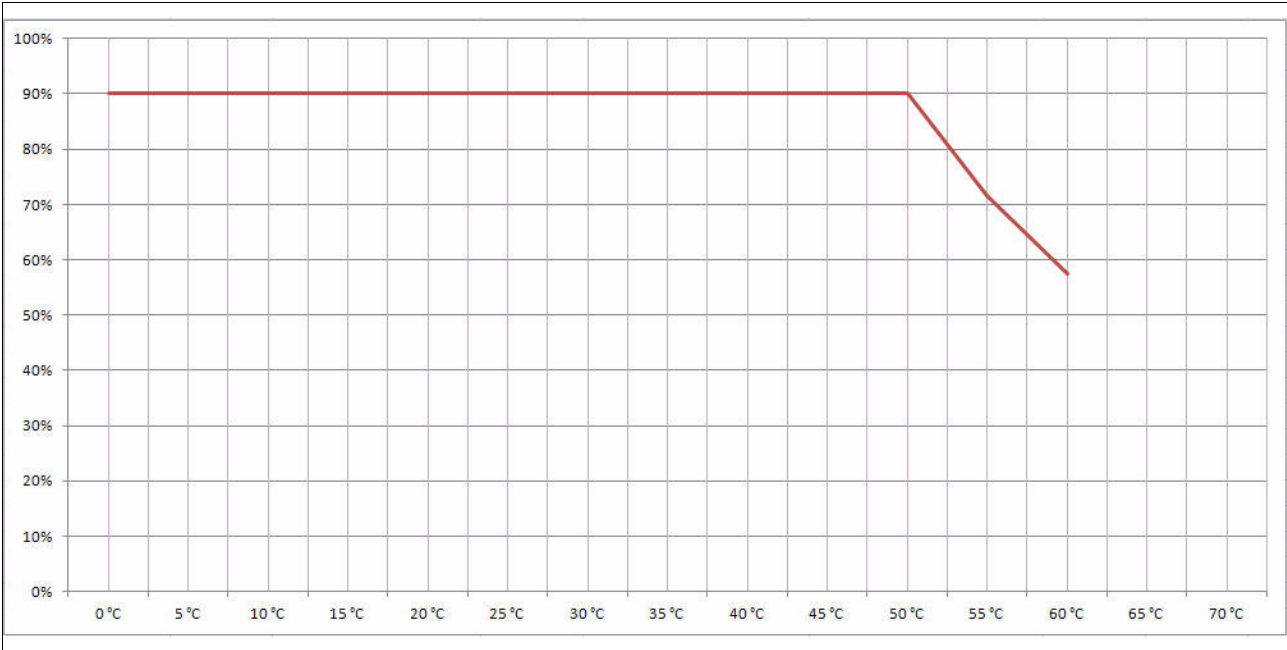

8.4.2 Max. relative humidity, storage

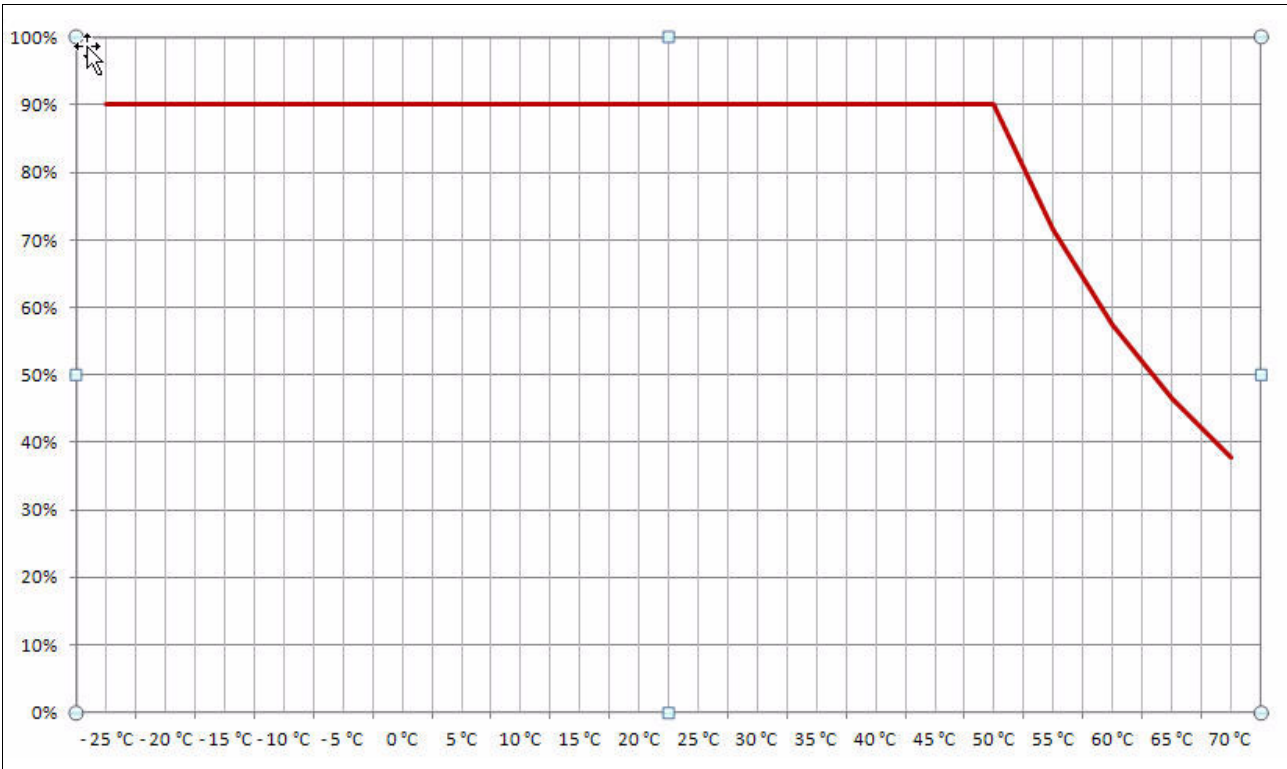

8.5 Order reference

Order reference

Product type	Features	Order no.
PNOZ m B0	Base unit	772 100

Order reference: Accessories

Product Type	Features	Order no.
PNOZ s Set1 spring-loaded terminals	1 set of spring-loaded terminals	751 008
PNOZ s Set1 screw terminals	1 set of screw terminals	750 008

Order reference: Terminator, jumper

Product type	Features	Order no.
PNOZ mm0.xp terminator left	Terminator, black/yellow, x1	779 261

Order reference: Cable

Product Type	Features	Order no.
PSSu A USB-CAB03	Mini USB cable, 3 m	312 992
PSSu A USB-CAB05	Mini USB cable, 5 m	312 993



► ...
In many countries we are represented by our subsidiaries and sales partners.

Please refer to our homepage for further details or contact our headquarters.

Pilz GmbH & Co. KG
Felix-Wankel-Straße 2
73760 Ostfildern, Germany
Telephone: +49 711 3409-0
Telefax: +49 711 3409-133
E-Mail: pilz.gmbh@pilz.de
Internet: www.pilz.com

► Technical support

+49 711 3409-444
support@pilz.com

pilz

IndurNET p[®], Pilz[®], PIT[®], PMCprotego[®], PMI[®], PNOZ[®], Primo[®], PSEN[®], PSS[®], PVIS[®], SafetyBUS P[®], SafetyEYE[®], SafetyNET p[®], the spirit of safety[®] are registered and protected trademarks of Pilz GmbH & Co. KG in some countries. We would point out that product features may vary from the details stated in this document, depending on the status at the time of publication and the scope of the equipment. We accept no responsibility for the validity, accuracy and entirety of the text and graphics presented in this information. Please contact our Technical Support if you have any questions.