

## RI 20N - B,C characteristics

Page 6-2



- Number of poles: 1+ N
- Tripping characteristics: B, C
- Rated current: 2 - 32 A
- Rated short capacity: 4.5 kA
- NF, CE

## RI 50 - B,C characteristics

Page 6-4



- Number of poles: 1, 1+N, 2, 3, 3+N, 4
- Tripping characteristics: B, C
- Rated current: 6 - 63 A
- Rated short capacity: 6 kA
- SEMKO, CE
- Accessories

## RI 60 - B,C,D characteristics - 10 kA

Page 6-7



- Number of poles: 1, 1+N, 2, 3, 3+N, 4
- Tripping characteristics: B, C, D
- Rated current: 0.5 - 63 A
- Rated short capacity: 10 kA
- VDE, EAC, CE
- Accessories

## RI 60J DC - C characteristics

Page 6-9

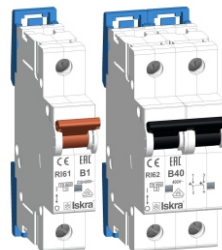

- Number of poles: 1, 2
- Tripping characteristics: C
- Rated current: 0.5 - 63 A
- Rated short capacity: 4.5 kA
- EAC, CE

## RI 100 - B characteristics - 10 kA

Page 2-19



- Number of poles: 1, 1+N, 2, 3, 3+N, 4
- Tripping characteristics: C
- Rated current: 80 - 125 A
- Rated short capacity: 10 kA
- SEMKO, CE

MINIATURE CIRCUIT BREAKERS OF RI SERIES ARE USED FOR SWITCHING, CONDUCTING AND SWITCHING-OFF THE CURRENT NOT ONLY IN NORMAL OPERATING CONDITIONS BUT ALSO IN SPECIAL CONDITIONS IN A CIRCUIT SUCH AS SHORT CIRCUIT. THEY ARE USED FOR OVERCURRENT PROTECTION OF HOUSE INSTALLATIONS, INDUSTRIAL ELECTRIC DISTRIBUTIONS AND DEVICES.

# MINIATURE CIRCUIT BREAKERS - RI20N



MINIATURE CIRCUIT BREAKERS OF RI SERIES ARE USED FOR SWITCHING, CONDUCTING AND SWITCHING-OFF THE CURRENT NOT ONLY IN NORMAL OPERATING CONDITIONS BUT ALSO IN SPECIAL CONDITIONS IN A CIRCUIT SUCH AS SHORT CIRCUIT. THEY ARE USED FOR OVERCURRENT PROTECTION OF HOUSE INSTALLATIONS, INDUSTRIAL ELECTRIC DISTRIBUTIONS AND DEVICES.

6

## BENEFITS

- Number of poles 1 + N
- Tripping characteristics B, C
- Rated current 2, 4, 6, 10, 16, 20, 25, 32 A
- Rated voltage 230 V
- Rated frequency 50 Hz
- Rated short capacity 4.5 kA
- Mounting to 35 mm wide mounting rail acc. with EN 60715
- Ambient temperature -5 ... +40 °C

## ORDERING DATA

- Miniature circuit breakers RI20N up to 32 A ..... page 6-3
- Accessories ..... page 6-11
- Connections ..... page 6-27
- Example - Ordering data ..... page 6-5
- Technical characteristics ..... page 6-13
- Dimensions ..... page 6-25

# MINIATURE CIRCUIT BREAKERS - RI20N

## RI20N - B characteristics

Type	Rated current I <sub>n</sub> (A)	Rated voltage U <sub>n</sub> (V)	Number of poles	Ordering No.	Weight (g)	Packaging (pcs)
RI20N B2	2	230	1 + N	30.100.408	120	10
RI20N B4	4	230	1 + N	30.100.368	120	10
RI20N B6	6	230	1 + N	30.100.369	120	10
RI20N B10	10	230	1 + N	30.100.370	120	10
RI20N B16	16	230	1 + N	30.100.371	120	10
RI20N B20	20	230	1 + N	30.100.372	120	10
RI20N B25	25	230	1 + N	30.100.373	120	10
RI20N B32	32	230	1 + N	30.100.374	120	10

4.5  
kA

## RI20N - C characteristics

Type	Rated current I <sub>n</sub> (A)	Rated voltage U <sub>n</sub> (V)	Number of poles	Ordering No.	Weight (g)	Packaging (pcs)
RI20N C2	2	230	1 + N	30.100.334	120	10
RI20N C4	4	230	1 + N	30.100.333	120	10
RI20N C6	6	230	1 + N	30.100.327	120	10
RI20N C10	10	230	1 + N	30.100.328	120	10
RI20N C16	16	230	1 + N	30.100.329	120	10
RI20N C20	20	230	1 + N	30.100.330	120	10
RI20N C25	25	230	1 + N	30.100.331	120	10
RI20N C32	32	230	1 + N	30.100.332	120	10

4.5  
kA

6

ORDERING DATA

# MINIATURE CIRCUIT BREAKERS - RI50



MINIATURE CIRCUIT BREAKERS OF RI 50 SERIES 50 ARE USED FOR THE PROTECTION OF INSTALLATIONS AND DEVICES (OVERLOAD AND SHORT CIRCUIT), AND AS A DISCONNECTOR IN CASE OF ELECTRIC SHOCK



## BENEFITS

- Due the low permissible  $I^2t$  (let through) values can be used smaller size of metal boxes
- Low let-through energy under short-circuit conditions ensures longer life of contacts and reduces thermal stresses in the distribution circuit
- RI 50 reduces the energy loss due to a unique contact configuration and reduction of hot spots. Watt loss per pole for RI 50 is far lower than that specified in IEC/EN 60898
- An optional operating position
- IP20 degree of protection; IP40 degree of protection after installation in a distribution box
- An additional colour indication of the position of main contacts (red: contacts closed; green: contacts open)

## TYPES

RI 51	single-pole
RI 51N	single pole + neutral pole
RI 52	two-pole
RI 53	three-pole
RI 53N	three-pole + neutral pole
RI 54	four pole

## ORDERING DATA

Miniature circuit breakers RI50 up to 63 A .....	page 6-5
Accessories .....	page 6-11
Connections .....	page 6-27
Example - Ordering data .....	page 6-5
Technical characteristics .....	page 6-13
Dimensions .....	page 6-25

# MINIATURE CIRCUIT BREAKERS - RI50

## RI50 - B characteristics

6  
kA

Type	Rated current I <sub>n</sub> (A)	Rated voltage U <sub>n</sub> (V)	Number of poles	Ordering No.	Weight (g)	Packaging (pcs)
RI51 B6	6	240	1	786.091.006	100	12
RI51 B10	10	240	1	786.091.007	100	12
RI51 B16	16	240	1	786.091.008	100	12
RI51 B20	20	240	1	786.091.009	100	12
RI51 B25	25	240	1	786.091.010	100	12
RI51 B32	32	240	1	786.091.011	100	12
RI51 B40	40	240	1	786.091.012	100	12
RI51 B50	50	240	1	786.091.013	100	12
RI51 B63	63	240	1	786.091.014	100	12
RI51N B6	6	240/415	1 + N	786.091.015	200	6
RI51N B10	10	240/415	1 + N	786.091.016	200	6
RI51N B16	16	240/415	1 + N	786.091.017	200	6
RI51N B20	20	240/415	1 + N	786.091.018	200	6
RI51N B25	25	240/415	1 + N	786.091.019	200	6
RI51N B32	32	240/415	1 + N	786.091.020	200	6
RI51N B40	40	240/415	1 + N	786.091.021	200	6
RI51N B50	50	240/415	1 + N	786.091.022	200	6
RI51N B63	63	240/415	1 + N	786.091.023	200	6
RI52 B6	6	240/415	2	786.091.024	200	6
RI52 B10	10	240/415	2	786.091.025	200	6
RI52 B16	16	240/415	2	786.091.026	200	6
RI52 B20	20	240/415	2	786.091.027	200	6
RI52 B25	25	240/415	2	786.091.028	200	6
RI52 B32	32	240/415	2	786.091.029	200	6
RI52 B40	40	240/415	2	786.091.030	200	6
RI52 B50	50	240/415	2	786.091.031	200	6
RI52 B63	63	240/415	2	786.091.032	200	6
RI53 B6	6	415	3	786.091.033	300	4
RI53 B10	10	415	3	786.091.034	300	4
RI53 B16	16	415	3	786.091.035	300	4
RI53 B20	20	415	3	786.091.036	300	4
RI53 B25	25	415	3	786.091.037	300	4
RI53 B32	32	415	3	786.091.038	300	4
RI53 B40	40	415	3	786.091.039	300	4
RI53 B50	50	415	3	786.091.040	300	4
RI53 B63	63	415	3	786.091.041	300	4
RI53N B6	6	415	3 + N	786.091.042	400	3
RI53N B10	10	415	3 + N	786.091.043	400	3
RI53N B16	16	415	3 + N	786.091.044	400	3
RI53N B20	20	415	3 + N	786.091.045	400	3
RI53N B25	25	415	3 + N	786.091.046	400	3
RI53N B32	32	415	3 + N	786.091.047	400	3
RI53N B40	40	415	3 + N	786.091.048	400	3
RI53N B50	50	415	3 + N	786.091.049	400	3
RI53N B63	63	415	3 + N	786.091.050	400	3
RI54 B6	6	415	4	786.091.051	400	3
RI54 B10	10	415	4	786.091.052	400	3
RI54 B16	16	415	4	786.091.053	400	3
RI54 B20	20	415	4	786.091.054	400	3
RI54 B25	25	415	4	786.091.055	400	3
RI54 B32	32	415	4	786.091.056	400	3
RI54 B40	40	415	4	786.091.057	400	3
RI54 B50	50	415	4	786.091.058	400	3
RI54 B63	63	415	4	786.091.059	400	3



6

ORDERING DATA

# MINIATURE CIRCUIT BREAKERS - RI50

## RI50 - C characteristics

6  
kA

Type	Rated current I <sub>n</sub> (A)	Rated voltage U <sub>n</sub> (V)	Number of poles	Ordering No.	Weight (g)	Packaging (pcs)
RI51 C6	6	240	1	786.091.100	100	12
RI51 C10	10	240	1	786.091.101	100	12
RI51 C16	16	240	1	786.091.102	100	12
RI51 C20	20	240	1	786.091.103	100	12
RI51 C25	25	240	1	786.091.104	100	12
RI51 C32	32	240	1	786.091.105	100	12
RI51 C40	40	240	1	786.091.106	100	12
RI51 C50	50	240	1	786.091.107	100	12
RI51 C63	63	240	1	786.091.108	100	12
RI51N C6	6	240/415	1 + N	786.091.109	200	6
RI51N C10	10	240/415	1 + N	786.091.110	200	6
RI51N C16	16	240/415	1 + N	786.091.111	200	6
RI51N C20	20	240/415	1 + N	786.091.112	200	6
RI51N C25	25	240/415	1 + N	786.091.113	200	6
RI51N C32	32	240/415	1 + N	786.091.114	200	6
RI51N C40	40	240/415	1 + N	786.091.115	200	6
RI51N C50	50	240/415	1 + N	786.091.116	200	6
RI51N C63	63	240/415	1 + N	786.091.117	200	6
RI52 C6	6	240/415	2	786.091.118	200	6
RI52 C10	10	240/415	2	786.091.119	200	6
RI52 C16	16	240/415	2	786.091.120	200	6
RI52 C20	20	240/415	2	786.091.121	200	6
RI52 C25	25	240/415	2	786.091.122	200	6
RI52 C32	32	240/415	2	786.091.123	200	6
RI52 C40	40	240/415	2	786.091.124	200	6
RI52 C50	50	240/415	2	786.091.125	200	6
RI52 C63	63	240/415	2	786.091.126	200	6
RI53 C6	6	415	3	786.091.127	300	4
RI53 C10	10	415	3	786.091.128	300	4
RI53 C16	16	415	3	786.091.129	300	4
RI53 C20	20	415	3	786.091.130	300	4
RI53 C25	25	415	3	786.091.131	300	4
RI53 C32	32	415	3	786.091.132	300	4
RI53 C40	40	415	3	786.091.133	300	4
RI53 C50	50	415	3	786.091.134	300	4
RI53 C63	63	415	3	786.091.135	300	4
RI53N C6	6	415	3 + N	786.091.136	400	3
RI53N C10	10	415	3 + N	786.091.137	400	3
RI53N C16	16	415	3 + N	786.091.138	400	3
RI53N C20	20	415	3 + N	786.091.139	400	3
RI53N C25	25	415	3 + N	786.091.140	400	3
RI53N C32	32	415	3 + N	786.091.141	400	3
RI53N C40	40	415	3 + N	786.091.142	400	3
RI53N C50	50	415	3 + N	786.091.143	400	3
RI53N C63	63	415	3 + N	786.091.144	400	3
RI54 C6	6	415	4	786.091.145	400	3
RI54 C10	10	415	4	786.091.146	400	3
RI54 C16	16	415	4	786.091.147	400	3
RI54 C20	20	415	4	786.091.148	400	3
RI54 C25	25	415	4	786.091.149	400	3
RI54 C32	32	415	4	786.091.150	400	3
RI54 C40	40	415	4	786.091.151	400	3
RI54 C50	50	415	4	786.091.152	400	3
RI54 C63	63	415	4	786.091.153	400	3

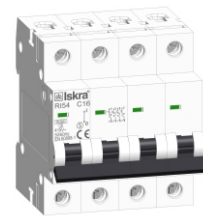
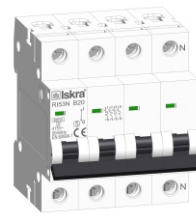

6

ORDERING DATA

## RI50

### Auxiliary contacts

Type	Ordering No.	Weight (g)	Packaging (pcs)
PS50E-11	786.091.154	42	1

### Shunt trip release

Type	Control voltages U <sub>c</sub> (V)	Ordering No.	Weight (g)	Packaging (pcs)
VC50E 230	230	786.091.155	82	1

### Undervoltage release

Type	Control voltages U <sub>c</sub> (V)	Ordering No.	Weight (g)	Packaging (pcs)
VC50E 230	110 - 415	786.091.156	78	1

# MINIATURE CIRCUIT BREAKERS - RI60

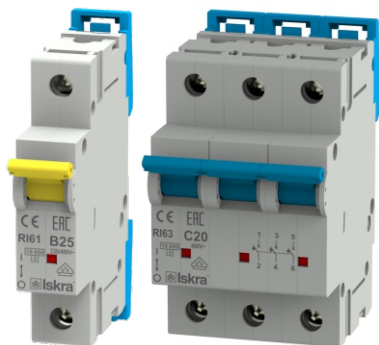

MINIATURE CIRCUIT BREAKERS OF RI 60 SERIES 50 ARE USED FOR OVER-CURRENT (OVERLOAD AND SHORT-CIRCUIT) PROTECTION OF INSTALLATIONS AND DEVICES, AND AS A DISCONNECTOR IN CASE OF ELECTRIC SHOCK.



## BENEFITS

- RI 60 miniature circuit breakers are provided with two springs for assembly to a 35 mm wide mounting rail (EN 60715).
- The springs enable simple taking off irrespective of whether a busbar is positioned below or above  
Special springs are available for fixing miniature circuit breakers with wo M5 screws
- A handle can be sealed in ON or OFF position
- Optional operation position
- Degree of protection IP20; degree of protection IP40 after installation in a distribution box
- Additional colour indication of the position of main contacts (red - contacts closed; green - contacts open)

## TYPES

RI 61	single-pole
RI 61N	single pole + neutral pole
RI 62	two-pole
RI 63	three-pole
RI 63N	three-pole + neutral pole
RI 64	four pole

## ORDERING DATA

Miniature circuit breakers RI60 up to 63 A .....	page 6-9
Accessories .....	page 6-11
Connections .....	page 6-27
Example - Ordering data .....	page 6-5
Technical characteristics .....	page 6-13
Dimensions .....	page 6-25



# MINIATURE CIRCUIT BREAKERS - RI60

## RI60 - B characteristics

10  
kA

Type	Rated current I <sub>n</sub> (A)	Rated voltage U <sub>n</sub> (V)	Number of poles	Ordering No.	Weight (g)	Packaging (pcs)
RI61 B0.5	0.5	230	1	786.100.031	128	12
RI61 B1	1	230	1	786.100.032	128	12
RI61 B2	2	230	1	786.100.033	128	12
RI61 B3	3	230	1	786.100.034	128	12
RI61 B4	4	230	1	786.100.035	128	12
RI61 B6	6	230	1	786.100.036	128	12
RI61 B8	8	230	1	786.100.037	128	12
RI61 B10	10	230	1	786.100.038	128	12
RI61 B13	13	230	1	786.100.039	128	12
RI61 B16	16	230	1	786.100.040	128	12
RI61 B20	20	230	1	786.100.041	128	12
RI61 B25	25	230	1	786.100.042	128	12
RI61 B32	32	230	1	786.100.043	128	12
RI61 B40	40	230	1	786.100.044	128	12
RI61 B50	50	230	1	786.100.045	128	12
RI61 B63	63	230	1	786.100.046	128	12
RI61N B0.5	0.5	230/400	1 + N	786.100.346	256	6
RI61N B1	1	230/400	1 + N	786.101.900	256	6
RI61N B2	2	230/400	1 + N	786.101.901	256	6
RI61N B3	3	230/400	1 + N	786.101.902	256	6
RI61N B4	4	230/400	1 + N	786.100.349	256	6
RI61N B6	6	230/400	1 + N	786.100.297	256	6
RI61N B8	8	230/400	1 + N	786.101.903	256	6
RI61N B10	10	230/400	1 + N	786.100.237	256	6
RI61N B13	13	230/400	1 + N	786.100.339	256	6
RI61N B16	16	230/400	1 + N	786.100.238	256	6
RI61N B20	20	230/400	1 + N	786.100.239	256	6
RI61N B25	25	230/400	1 + N	786.100.240	256	6
RI61N B32	32	230/400	1 + N	786.100.241	256	6
RI61N B40	40	230/400	1 + N	786.100.242	256	6
RI61N B50	50	230/400	1 + N	786.100.243	256	6
RI61N B63	63	230/400	1 + N	786.100.364	256	6
RI62 B0.5	0.5	230/400	2	786.100.127	256	6
RI62 B1	1	230/400	2	786.101.128	256	6
RI62 B2	2	230/400	2	786.101.129	256	6
RI62 B3	3	230/400	2	786.101.130	256	6
RI62 B4	4	230/400	2	786.100.131	256	6
RI62 B6	6	230/400	2	786.100.132	256	6
RI62 B8	8	230/400	2	786.101.133	256	6
RI62 B10	10	230/400	2	786.100.134	256	6
RI62 B13	13	230/400	2	786.100.135	256	6
RI62 B16	16	230/400	2	786.100.136	256	6
RI62 B20	20	230/400	2	786.100.137	256	6
RI62 B25	25	230/400	2	786.100.138	256	6
RI62 B32	32	230/400	2	786.100.139	256	6
RI62 B40	40	230/400	2	786.100.140	256	6
RI62 B50	50	230/400	2	786.100.141	256	6
RI62 B63	63	230/400	2	786.100.142	256	6
RI63 B0.5	0.5	400	3	786.100.079	384	4
RI63 B1	1	400	3	786.101.080	384	4
RI63 B2	2	400	3	786.101.081	384	4
RI63 B3	3	400	3	786.101.082	384	4
RI63 B4	4	400	3	786.100.083	384	4
RI63 B6	6	400	3	786.100.084	384	4
RI63 B8	8	400	3	786.101.085	384	4
RI63 B10	10	400	3	786.100.086	384	4
RI63 B13	13	400	3	786.100.087	384	4
RI63 B16	16	400	3	786.100.088	384	4
RI63 B20	20	400	3	786.100.089	384	4
RI63 B25	25	400	3	786.100.090	384	4
RI63 B32	32	400	3	786.100.091	384	4
RI63 B40	40	400	3	786.100.092	384	4
RI63 B50	50	400	3	786.100.093	384	4
RI63 B63	63	400	3	786.100.094	384	4

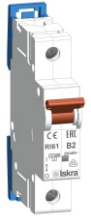

6

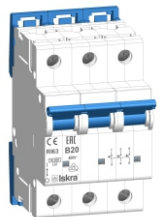
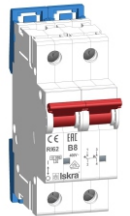

ORDERING DATA

# MINIATURE CIRCUIT BREAKERS - RI60

## RI60 - B characteristics

Type	Rated current I <sub>n</sub> (A)	Rated voltage U <sub>n</sub> (V)	Number of poles	Ordering No.	Weight (g)	Packaging (pcs)
RI63N B0.5	0.5	400	3 + N	786.101.919	494	3
RI63N B1	1	400	3 + N	786.101.920	494	3
RI63N B2	2	400	3 + N	786.101.921	494	3
RI63N B3	3	400	3 + N	786.101.922	494	3
RI63N B4	4	400	3 + N	786.101.923	494	3
RI63N B6	6	400	3 + N	786.100.360	494	3
RI63N B8	8	400	3 + N	786.101.924	494	3
RI63N B10	10	400	3 + N	786.100.246	494	3
RI63N B13	13	400	3 + N	786.100.342	494	3
RI63N B16	16	400	3 + N	786.100.247	494	3
RI63N B20	20	400	3 + N	786.100.248	494	3
RI63N B25	25	400	3 + N	786.100.249	494	3
RI63N B32	32	400	3 + N	786.100.250	494	3
RI63N B40	40	400	3 + N	786.100.251	494	3
RI63N B50	50	400	3 + N	786.100.252	494	3
RI63N B63	63	400	3 + N	786.100.253	494	3
RI64 B0.5	0.5	400	4	786.100.175	512	3
RI64 B1	1	400	4	786.100.176	512	3
RI64 B2	2	400	4	786.100.177	512	3
RI64 B3	3	400	4	786.100.178	512	3
RI64 B4	4	400	4	786.100.179	512	3
RI64 B6	6	400	4	786.100.180	512	3
RI64 B8	8	400	4	786.100.181	512	3
RI64 B10	10	400	4	786.100.182	512	3
RI64 B13	13	400	4	786.100.183	512	3
RI64 B16	16	400	4	786.100.184	512	3
RI64 B20	20	400	4	786.100.185	512	3
RI64 B25	25	400	4	786.100.186	512	3
RI64 B32	32	400	4	786.100.187	512	3
RI64 B40	40	400	4	786.100.188	512	3
RI64 B50	50	400	4	786.100.189	512	3
RI64 B63	63	400	4	786.100.190	512	3

10  
kA

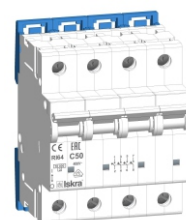

6

ORDERING DATA

# MINIATURE CIRCUIT BREAKERS - RI60

## Ri60 - C characteristics

10  
kA

Type	Rated current I <sub>n</sub> (A)	Rated voltage U <sub>n</sub> (V)	Number of poles	Ordering No.	Weight (g)	Packaging (pcs)
RI61 C0.5	0.5	230	1	786.100.047	128	12
RI61 C1	1	230	1	786.100.048	128	12
RI61 C2	2	230	1	786.100.049	128	12
RI61 C3	3	230	1	786.100.050	128	12
RI61 C4	4	230	1	786.100.051	128	12
RI61 C6	6	230	1	786.100.052	128	12
RI61 C8	8	230	1	786.100.053	128	12
RI61 C10	10	230	1	786.100.054	128	12
RI61 C13	13	230	1	786.100.055	128	12
RI61 C16	16	230	1	786.100.056	128	12
RI61 C20	20	230	1	786.100.057	128	12
RI61 C25	25	230	1	786.100.058	128	12
RI61 C32	32	230	1	786.100.059	128	12
RI61 C40	40	230	1	786.100.060	128	12
RI61 C50	50	230	1	786.100.061	128	12
RI61 C63	63	230	1	786.100.062	128	12
RI61N C0.5	0.5	230/400	1 + N	786.100.347	256	6
RI61N C1	1	230/400	1 + N	786.100.363	256	6
RI61N C2	2	230/400	1 + N	786.100.338	256	6
RI61N C3	3	230/400	1 + N	786.101.904	256	6
RI61N C4	4	230/400	1 + N	786.100.361	256	6
RI61N C6	6	230/400	1 + N	786.100.341	256	6
RI61N C8	8	230/400	1 + N	786.101.905	256	6
RI61N C10	10	230/400	1 + N	786.100.325	256	6
RI61N C13	13	230/400	1 + N	786.100.344	256	6
RI61N C16	16	230/400	1 + N	786.100.326	256	6
RI61N C20	20	230/400	1 + N	786.100.327	256	6
RI61N C25	25	230/400	1 + N	786.100.328	256	6
RI61N C32	32	230/400	1 + N	786.100.329	256	6
RI61N C40	40	230/400	1 + N	786.100.354	256	6
RI61N C50	50	230/400	1 + N	786.100.340	256	6
RI61N C63	63	230/400	1 + N	786.100.316	256	6
RI62 C0.5	0.5	230/400	2	786.100.143	256	6
RI62 C1	1	230/400	2	786.101.144	256	6
RI62 C2	2	230/400	2	786.101.145	256	6
RI62 C3	3	230/400	2	786.101.146	256	6
RI62 C4	4	230/400	2	786.100.147	256	6
RI62 C6	6	230/400	2	786.100.148	256	6
RI62 C8	8	230/400	2	786.101.149	256	6
RI62 C10	10	230/400	2	786.100.150	256	6
RI62 C13	13	230/400	2	786.100.151	256	6
RI62 C16	16	230/400	2	786.100.152	256	6
RI62 C20	20	230/400	2	786.100.153	256	6
RI62 C25	25	230/400	2	786.100.154	256	6
RI62 C32	32	230/400	2	786.100.155	256	6
RI62 C40	40	230/400	2	786.100.156	256	6
RI62 C50	50	230/400	2	786.100.157	256	6
RI62 C63	63	230/400	2	786.100.158	256	6
RI63 C0.5	0.5	400	3	786.100.095	384	4
RI63 C1	1	400	3	786.100.096	384	4
RI63 C2	2	400	3	786.100.097	384	4
RI63 C3	3	400	3	786.100.098	384	4
RI63 C4	4	400	3	786.100.099	384	4
RI63 C6	6	400	3	786.100.100	384	4
RI63 C8	8	400	3	786.100.101	384	4
RI63 C10	10	400	3	786.100.102	384	4
RI63 C13	13	400	3	786.100.103	384	4
RI63 C16	16	400	3	786.100.104	384	4
RI63 C20	20	400	3	786.100.105	384	4
RI63 C25	25	400	3	786.100.106	384	4
RI63 C32	32	400	3	786.100.107	384	4
RI63 C40	40	400	3	786.100.108	384	4
RI63 C50	50	400	3	786.100.109	384	4
RI63 C63	63	400	3	786.100.110	384	4

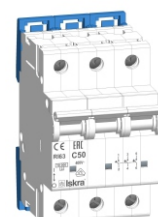
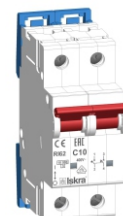

6

ORDERING DATA

# MINIATURE CIRCUIT BREAKERS - RI60

## RI60 - C characteristics

Type	Rated current I <sub>n</sub> (A)	Rated voltage U <sub>n</sub> (V)	Number of poles	Ordering No.	Weight (g)	Packaging (pcs)
RI63N C0.5	0.5	400	3 + N	786.101.906	494	3
RI63N C1	1	400	3 + N	786.100.378	494	3
RI63N C2	2	400	3 + N	786.100.379	494	3
RI63N C3	3	400	3 + N	786.101.907	494	3
RI63N C4	4	400	3 + N	786.100.380	494	3
RI63N C6	6	400	3 + N	786.100.232	494	3
RI63N C8	8	400	3 + N	786.101.908	494	3
RI63N C10	10	400	3 + N	786.100.233	494	3
RI63N C13	13	400	3 + N	786.101.918	494	3
RI63N C16	16	400	3 + N	786.100.234	494	3
RI63N C20	20	400	3 + N	786.100.235	494	3
RI63N C25	25	400	3 + N	786.100.228	494	3
RI63N C32	32	400	3 + N	786.100.227	494	3
RI63N C40	40	400	3 + N	786.100.229	494	3
RI63N C50	50	400	3 + N	786.100.230	494	3
RI63N C63	63	400	3 + N	786.100.231	494	3
RI64 C0.5	0.5	400	4	786.100.191	512	3
RI64 C1	1	400	4	786.100.192	512	3
RI64 C2	2	400	4	786.100.193	512	3
RI64 C3	3	400	4	786.100.194	512	3
RI64 C4	4	400	4	786.100.195	512	3
RI64 C6	6	400	4	786.100.196	512	3
RI64 C8	8	400	4	786.100.197	512	3
RI64 C10	10	400	4	786.100.198	512	3
RI64 C13	13	400	4	786.100.199	512	3
RI64 C16	16	400	4	786.100.200	512	3
RI64 C20	20	400	4	786.100.201	512	3
RI64 C25	25	400	4	786.100.202	512	3
RI64 C32	32	400	4	786.100.203	512	3
RI64 C40	40	400	4	786.100.204	512	3
RI64 C50	50	400	4	786.100.205	512	3
RI64 C63	63	400	4	786.100.206	512	3

10  
kA

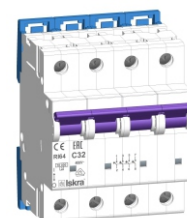

6

ORDERING DATA

# MINIATURE CIRCUIT BREAKERS - RI60

## RI60 - D characteristics

10  
kA

Type	Rated current I <sub>n</sub> (A)	Rated voltage U <sub>n</sub> (V)	Number of poles	Ordering No.	Weight (g)	Packaging (pcs)
RI61 D0.5	0.5	230	1	786.100.063	128	12
RI61 D1	1	230	1	786.100.064	128	12
RI61 D2	2	230	1	786.100.065	128	12
RI61 D3	3	230	1	786.100.066	128	12
RI61 D4	4	230	1	786.100.067	128	12
RI61 D6	6	230	1	786.100.068	128	12
RI61 D8	8	230	1	786.100.069	128	12
RI61 D10	10	230	1	786.100.070	128	12
RI61 D13	13	230	1	786.100.071	128	12
RI61 D16	16	230	1	786.100.072	128	12
RI61 D20	20	230	1	786.100.073	128	12
RI61 D25	25	230	1	786.100.074	128	12
RI61 D32	32	230	1	786.100.075	128	12
RI61 D40	40	230	1	786.100.076	128	12
RI61 D50	50	230	1	786.100.077	128	12
RI61 D63	63	230	1	786.100.078	128	12
RI62 D0.5	0.5	230/400	2	786.101.159	256	6
RI62 D1	1	230/400	2	786.101.160	256	6
RI62 D2	2	230/400	2	786.101.161	256	6
RI62 D3	3	230/400	2	786.101.162	256	6
RI62 D4	4	230/400	2	786.101.163	256	6
RI62 D6	6	230/400	2	786.101.164	256	6
RI62 D8	8	230/400	2	786.101.165	256	6
RI62 D10	10	230/400	2	786.101.166	256	6
RI62 D13	13	230/400	2	786.101.167	256	6
RI62 D16	16	230/400	2	786.101.168	256	6
RI62 D20	20	230/400	2	786.101.169	256	6
RI62 D25	25	230/400	2	786.101.170	256	6
RI62 D32	32	230/400	2	786.101.171	256	6
RI62 D40	40	230/400	2	786.101.172	256	6
RI62 D50	50	230/400	2	786.101.173	256	6
RI62 D63	63	230/400	2	786.101.174	256	6
RI63 D0.5	0.5	400	3	786.100.111	384	4
RI63 D1	1	400	3	786.100.112	384	4
RI63 D2	2	400	3	786.100.113	384	4
RI63 D3	3	400	3	786.100.114	384	4
RI63 D4	4	400	3	786.100.115	384	4
RI63 D6	6	400	3	786.100.116	384	4
RI63 D8	8	400	3	786.100.117	384	4
RI63 D10	10	400	3	786.100.118	384	4
RI63 D13	13	400	3	786.100.119	384	4
RI63 D16	16	400	3	786.100.120	384	4
RI63 D20	20	400	3	786.100.121	384	4
RI63 D25	25	400	3	786.100.122	384	4
RI63 D32	32	400	3	786.100.123	384	4
RI63 D40	40	400	3	786.100.124	384	4
RI63 D50	50	400	3	786.100.125	384	4
RI63 D63	63	400	3	786.100.126	384	4
RI63N D0.5	0.5	400	3 + N	786.101.909	494	3
RI63N D1	1	400	3 + N	786.101.910	494	3
RI63N D2	2	400	3 + N	786.101.911	494	3
RI63N D3	3	400	3 + N	786.101.912	494	3
RI63N D4	4	400	3 + N	786.100.274	494	3
RI63N D6	6	400	3 + N	786.100.275	494	3
RI63N D8	8	400	3 + N	786.101.913	494	3
RI63N D10	10	400	3 + N	786.100.276	494	3
RI63N D13	13	400	3 + N	786.101.914	494	3
RI63N D16	16	400	3 + N	786.100.277	494	3
RI63N D20	20	400	3 + N	786.100.278	494	3
RI63N D25	25	400	3 + N	786.100.279	494	3
RI63N D32	32	400	3 + N	786.100.280	494	3
RI63N D40	40	400	3 + N	786.100.281	494	3
RI63N D50	50	400	3 + N	786.100.282	494	3
RI63N D63	63	400	3 + N	786.100.283	494	3

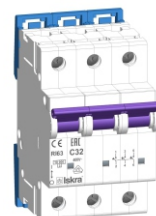
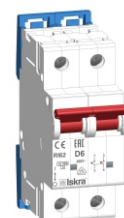

6

ORDERING DATA

# MINIATURE CIRCUIT BREAKERS - RI60

## RI60 - D characteristics

Type	Rated current I <sub>n</sub> (A)	Rated voltage U <sub>n</sub> (V)	Number of poles	Ordering No.	Weight (g)	Packaging (pcs)
RI64 D0.5	0.5	400	4	786.100.207	512	3
RI64 D1	1	400	4	786.100.208	512	3
RI64 D2	2	400	4	786.100.209	512	3
RI64 D3	3	400	4	786.100.210	512	3
RI64 D4	4	400	4	786.100.211	512	3
RI64 D6	6	400	4	786.100.212	512	3
RI64 D8	8	400	4	786.100.213	512	3
RI64 D10	10	400	4	786.100.214	512	3
RI64 D13	13	400	4	786.100.215	512	3
RI64 D16	16	400	4	786.100.216	512	3
RI64 D20	20	400	4	786.100.217	512	3
RI64 D25	25	400	4	786.100.218	512	3
RI64 D32	32	400	4	786.100.219	512	3
RI64 D40	40	400	4	786.100.220	512	3
RI64 D50	50	400	4	786.100.221	512	3
RI64 D63	63	400	4	786.100.222	512	3

10  
kA

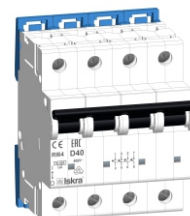

6

## MINIATURE CIRCUIT BREAKERS RI60J DC

### RI60J - C characteristics

Type	Rated current I <sub>n</sub> (A)	Rated voltage U <sub>n</sub> (V)	Number of poles	Ordering No.	Weight (g)	Packaging (pcs)
RI61J C0.5	0.5	220	1	786.100.345	128	12
RI61J C1	1	220	1	786.100.295	128	12
RI61J C2	2	220	1	786.100.293	128	12
RI61J C3	3	220	1	786.100.298	128	12
RI61J C4	4	220	1	786.100.263	128	12
RI61J C6	6	220	1	786.100.264	128	12
RI61J C8	8	220	1	786.100.265	128	12
RI61J C10	10	220	1	786.100.266	128	12
RI61J C16	16	220	1	786.100.267	128	12
RI61J C20	20	220	1	786.100.268	128	12
RI61J C25	25	220	1	786.100.269	128	12
RI61J C32	32	220	1	786.100.270	128	12
RI61J C40	40	220	1	786.100.271	128	12
RI61J C50	50	220	1	786.100.272	128	12
RI61J C63	63	220	1	786.100.273	128	12
RI62J C0.5	0.5	440	2	786.100.350	248	6
RI62J C1	1	440	2	786.100.351	248	6
RI62J C2	2	440	2	786.100.285	248	6
RI62J C3	3	440	2	786.100.299	248	6
RI62J C4	4	440	2	786.100.286	248	6
RI62J C6	6	440	2	786.100.287	248	6
RI62J C8	8	440	2	786.100.353	248	6
RI62J C10	10	440	2	786.100.288	248	6
RI62J C16	16	440	2	786.100.289	248	6
RI62J C20	20	440	2	786.100.290	248	6
RI62J C25	25	440	2	786.100.291	248	6
RI62J C32	32	440	2	786.100.292	248	6
RI62J C40	40	440	2	786.100.296	248	6
RI62J C50	50	440	2	786.100.352	248	6
RI62J C63	63	440	2	786.100.294	248	6

4.5  
kA

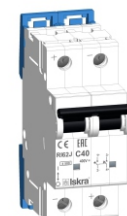

ORDERING DATA

# MINIATURE CIRCUIT BREAKERS - ACCESSORIES

RI60

## AUXILIARY CONTACT BLOCK

For side mounting PK and 2PK

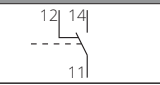
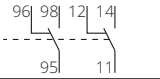
Type	Number of contacts	Wiring diagram	Ordering No.	Weight (g)	Packaging (pcs)
PKJ	1 (change-over)		786.105.002	45	1
2PKJ	2 (change-over)		786.105.014	53	1

With trip-indicating contact PKJ + SKJ

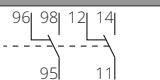
Type	Number of contacts	Wiring diagram	Ordering No.	Weight (g)	Packaging (pcs)
PKJ + SKJ	1 + 1		786.105.025	104	1

Shunt trip release

Type	Control voltages $U_c$ (V)	Ordering No.	Weight (g)	Packaging (pcs)
VC	230	786.100.300	90	1

Undervoltage release

Type	Control voltages $U_c$ (V)	Ordering No.	Weight (g)	Packaging (pcs)
PC60	230	786.100.332	114	1

6

ORDERING DATA

# MINIATURE CIRCUIT BREAKERS - ACCESSORIES

## RI60

### Covers of terminal

Type	Ordering No.	Weight (g)	Packaging (pcs)
KSP1 (one-phase)	786.101.916	5.5	1
KSP3 (three-phase)	786.101.915	53	1

### Locking of operating means

Type	Ordering No.	Weight (g)	Packaging (pcs)
UP	786.105.034	5	1

### Sealing blind

Type	Ordering No.	Weight (g)	Packaging (pcs)
PZ	786.101.917	6	1

### One-phase busbars - insulated

Type	Module width	Lenght (mm)	Ordering No.	Weight (g)	Packaging (pcs)
G-1L-210/852K	12	210	786.105.045	65	1
G-1L-210/ES11210	12	210	786.105.035	86	1
G-1L-1000/10/852	57	1000	786.105.037	190	1

### Two-phase busbars - insulated

Type	Module width	Lenght (mm)	Ordering No.	Weight (g)	Packaging (pcs)
G-2L-1000/10	57	1000	786.105.019	315	1
G-2L-1000/16C	57	1000	786.105.023	450	1

### Three-phase busbars - insulated

Type	Module width	Lenght (mm)	Ordering No.	Weight (g)	Packaging (pcs)
G-3L-210/10(700)	12	210	786.105.038	160	1
G-3L-1000/10(710)	57	1000	786.105.039	510	1
G-3L-1000/16(710/16/57)	57	1000	786.105.036	640	1

### Four-phase busbars - insulated

Type	Module width	Lenght (mm)	Ordering No.	Weight (g)	Packaging (pcs)
G-4L-1000/16C	57	1000	786.105.013	540	1
G-4L-1000/10P(716)	57	1000	786.105.041	630	1

### End caps (for three-phase busbars)

Type	Ordering No.	Weight (g)	Packaging (pcs)
EK-C-3/10	786.105.011	0.7	1
EK-C-2+3/16	786.105.012	0.9	1



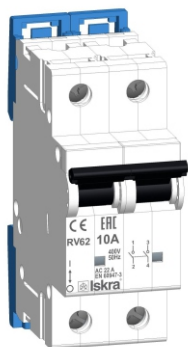

MODULAR SWITCHES RV 60 ARE MECHANICAL DEVICES USED FOR SWITCHING OF ELECTRICAL CIRCUITS. THEY ARE USED IN HOUSE, COMMERCIAL AND INDUSTRIAL DISTRIBUTIONS.



## TYPES OF MODULAR SWITCHES

RV 61	single-pole
RV 61N	single pole + neutral pole
RV 62	two-pole
RV 63	three-pole
RV 63N	three-pole + neutral pole
RV 64	four pole

## TYPES OF SIGNAL LAMPS

RST	transparent
RSR	red
RSB	blue
RSG	green
RSY	yellow

## ORDERING DATA

Miniature circuit breakers RI100 up to 125 A .....	page 6-18
Connections .....	page 6-11
Example - Ordering data .....	page 6-13
Technical characteristics .....	page 6-15
Dimensions .....	page 6-25

# MODULAR SWITCHES - RV 60 , SIGNAL LAMPS - RS

## RV60

### Modular switches

Type	Rated thermal current $I_{th}$ (A)	Number of poles	Ordering No.	Weight (g)	Packaging (pcs)
RV61	25	1	786.100.223	100	12
RV61	32	1	786.100.385	100	12
RV61	40	1	786.100.386	110	12
RV61	63	1	786.100.224	110	12
RV61N	25	1 + N	786.100.388	200	6
RV61N	40	1 + N	786.100.244	220	6
RV61N	63	1 + N	786.100.348	220	6
RV62	25	2	786.100.432	200	6
RV62	32	2	786.100.383	200	6
RV62	40	2	786.100.375	220	6
RV62	63	2	786.100.433	220	6
RV63	25	3	786.100.225	300	4
RV63	32	3	786.100.488	300	4
RV63	40	3	786.110.039	330	4
RV63	63	3	786.100.226	330	4
RV63N	32	3 + N	786.100.489	400	3
RV63N	40	3 + N	786.100.245	440	3
RV63N	63	3 + N	786.100.459	440	3
RV64	63	3 + N	786.100.460	440	3



6

## RS60

### Signal lamps

Type	Ordering No.	Weight (g)	Packaging (pcs)
RST230 Transparent	786.200.930	65	12
RSR230 Red	786.100.399	65	12
RSB230 Blue	786.100.397	65	12
RSG230 Green	786.100.398	65	12
RSY230 Yellow	786.201.060	65	12

ORDERING DATA

# MINIATURE CIRCUIT BREAKERS - RI100



MINIATURE CIRCUIT BREAKERS OF RI 100 SERIES ARE USED FOR SWITCHING, CONDUCTING AND SWITCHING-OFF THE CURRENT NOT ONLY IN NORMAL OPERATING CONDITIONS BUT ALSO IN SPECIAL CONDITIONS IN A CIRCUIT SUCH AS SHORT CIRCUIT. THEY ARE USED FOR OVERCURRENT PROTECTION OF HOUSE INSTALLATIONS, INDUSTRIAL ELECTRIC DISTRIBUTIONS AND DEVICES.



## BENEFITS

- High rated short-circuit breaking capacity up to 10 kA on IEC 60947-2/ IEC 60898-1 standard
- Service life of product has been greatly enhanced through special designed tripping mechanism
- Long-time and reliable operation
- Enclosure and functional parts made from imported plastics with flame-retardant, heat-resistant, and impulse-proof properties
- Compact and modularized design
- Convenient mounting

## TYPES

RI 101	single-pole
RI 101N	single pole + neutral pole
RI 102	two-pole
RI 103	three-pole
RI 103N	three-pole + neutral pole
RI 104	four pole

## ORDERING DATA

Miniature circuit breakers RI100 up to 125 A .....	page 6-18
Connections .....	page 6-11
Example - Ordering data .....	page 6-13
Technical characteristics .....	page 6-15
Dimensions .....	page 6-25

# MINIATURE CIRCUIT BREAKERS - RI100

## RI100 - C characteristics

Type	Rated current I <sub>n</sub> (A)	Rated voltage U <sub>n</sub> (V)	Number of poles	Ordering No.	Weight (g)	Packaging (pcs)
RI101 C80	80	230	1	786.101.250	160	8
RI101 C100	100	230	1	786.101.251	160	8
RI101 C125	125	230	1	786.101.252	160	8

10  
kA

## RI100 - C characteristics

Type	Rated current I <sub>n</sub> (A)	Rated voltage U <sub>n</sub> (V)	Number of poles	Ordering No.	Weight (g)	Packaging (pcs)
RI101N C80	80	230/400	1 + N	786.101.253	320	4
RI101N C100	100	230/400	1 + N	786.101.254	320	4
RI101N C125	125	230/400	1 + N	786.101.255	320	4

10  
kA

## RI100 - C characteristics

Type	Rated current I <sub>n</sub> (A)	Rated voltage U <sub>n</sub> (V)	Number of poles	Ordering No.	Weight (g)	Packaging (pcs)
RI102 C80	80	230/400	2	786.101.256	320	4
RI102 C100	100	230/400	2	786.101.257	320	4
RI102 C125	125	230/400	2	786.101.258	320	4

10  
kA

## RI100 - C characteristics

Type	Rated current I <sub>n</sub> (A)	Rated voltage U <sub>n</sub> (V)	Number of poles	Ordering No.	Weight (g)	Packaging (pcs)
RI103 C80	80	400	3	786.101.259	490	2
RI103 C100	100	400	3	786.101.260	490	2
RI103 C125	125	400	3	786.101.261	490	2

10  
kA

## RI100 - C characteristics

Type	Rated current I <sub>n</sub> (A)	Rated voltage U <sub>n</sub> (V)	Number of poles	Ordering No.	Weight (g)	Packaging (pcs)
RI103N C80	80	230/400	3 + N	786.101.262	640	2
RI103N C100	100	230/400	3 + N	786.101.263	640	2
RI103N C125	125	230/400	3 + N	786.101.264	640	2

10  
kA

## RI100 - C characteristics

Type	Rated current I <sub>n</sub> (A)	Rated voltage U <sub>n</sub> (V)	Number of poles	Ordering No.	Weight (g)	Packaging (pcs)
RI104 C80	80	400	4	786.101.265	640	2
RI104 C100	100	400	4	786.101.266	640	2
RI104 C125	125	400	4	786.101.267	640	2

10  
kA

6

ORDERING DATA

# MINIATURE CIRCUIT BREAKERS - RI20N

Type	Symbol	Unit	RI20N
Area of use			AC systems
Standards			IEC/EN 60898
Approvals			NF, CE
Number of poles			1+N
Tripping characteristics			B, C
Rated currents	$I_n$	A	2 ... 32
Rated voltage	$U_n$	V	230
Rated impulse withstand voltage	$U_{imp}$	kV	4
Rated insulation voltage	$U_i$	V	500
Rated frequency	f	Hz	50
Rated short-circuit breaking capacity	$I_{cu}, I_{cn}$	kA	4,5
Selectivity class			3
Electrical endurance		op.c.	4000
Mechanical endurance		op.c.	100 000
Terminal capacity		mm <sup>2</sup>	1 ... 10
Screw type			M4
Screw head			PZ2
Tightening torque		Nm	2
Mounting			35 mm DIN rail
Degree of protection			IP 20
Ambient temperature		°C	-25 ... 55
Altitude		m	2000
Above max. altitude the voltages $U_i$ and $U_n$ are reduced by 1.2%, nominal rating $I_n$ is reduced by 0.4% for every additional 100 m			
Mounting position			any
Resistance against vibrations			3 g (8 ... 50 Hz)

6

TECHNICAL DATA

# MINIATURE CIRCUIT BREAKERS - R120N

## Tripping characteristics

Characteristics B acc. to EN 60 898

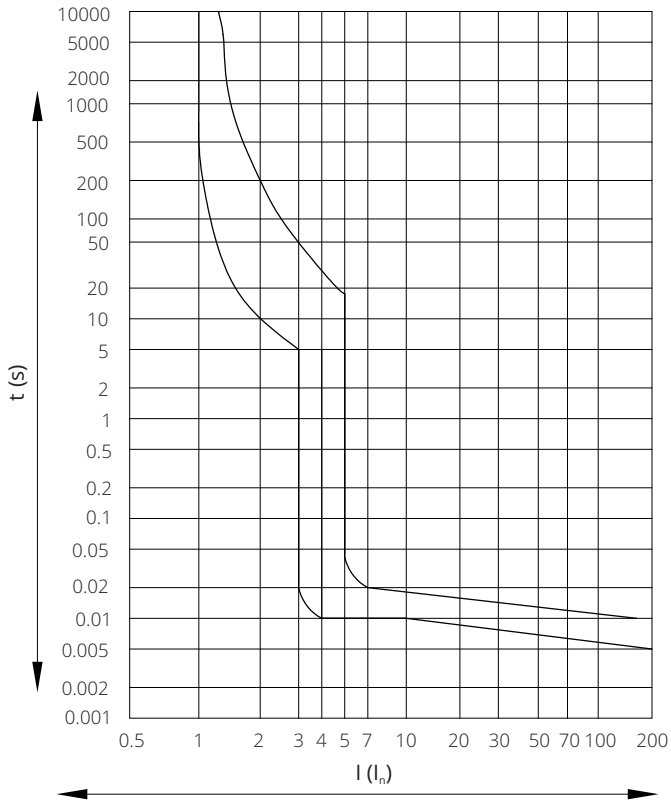

Characteristics C acc. to EN 60 898

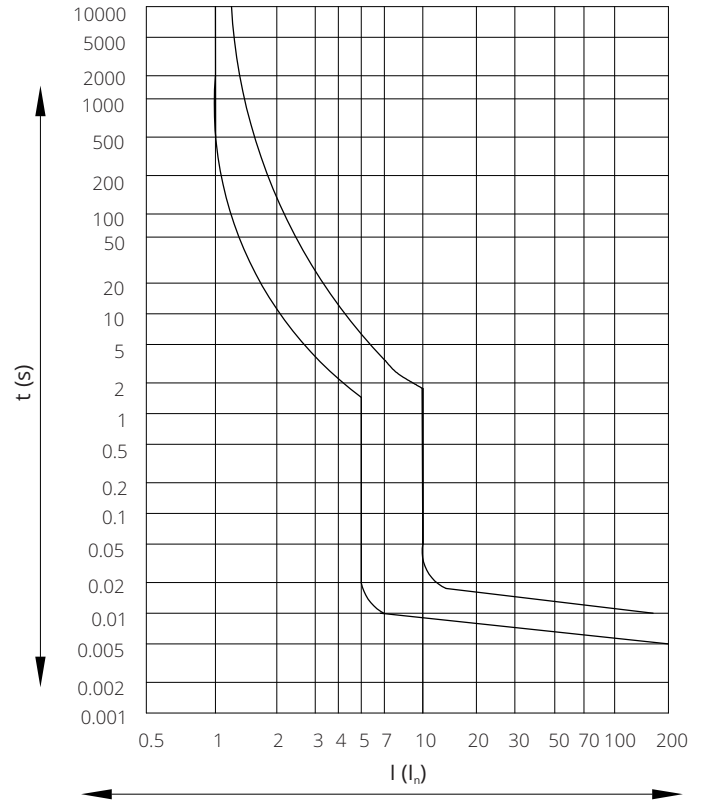

## Dimensions

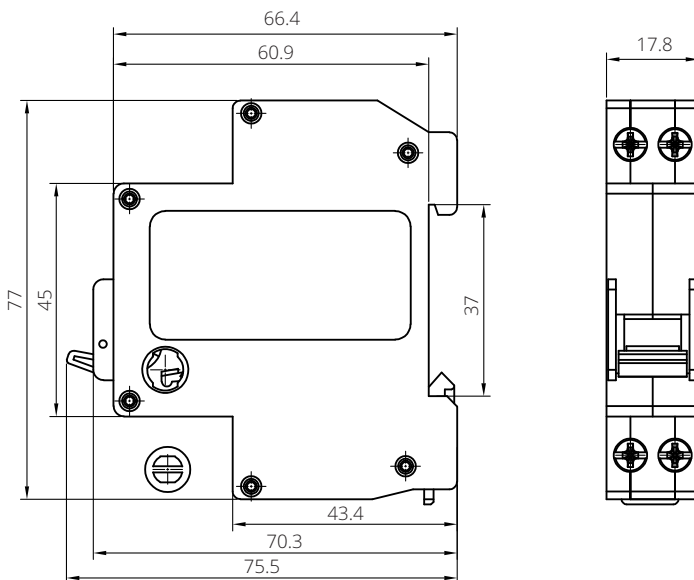

# MINIATURE CIRCUIT BREAKERS - RI50

Type	Symbol	Unit	RI50
Area of use			AC systems
Standards			IEC/EN 60898-1
Approvals			SEMKO, CE
Number of poles			1,1+N, 2, 3, 3+N, 4
Tripping characteristics			B, C
Rated currents	$I_n$	A	6 ... 63
Rated voltage	$U_n$	V	240/415 (single-pole) 415 (multi-pole)
Rated DC voltage	$U_n$	V	60 (single-pole) 110 (multi-pole)
Max. time constant for DC voltage	t	ms	15/60 V DC max.
Rated impulse withstand voltage	$U_{imp}$	kV	4
Rated insulation voltage	$U_i$	V	500
Rated frequency	f	Hz	50/60
Rated short-circuit breaking capacity	$I_{cu}$ , $I_{cn}$	kA	6
Service short-circuit breaking capacity	$I_{cs}$	kA	6
Selectivity class			3
Electrical endurance		op.c.	4000
Mechanical endurance		op.c.	100 000
Terminal capacity		mm <sup>2</sup>	up to 25
Screw type			M5
Screw head			PZ2
Tightening torque		Nm	2
Mounting			35 mm DIN rail acc. to EN 60715
Degree of protection			IP 20
Ambient temperature		°C	-25 ... 55
Altitude Above max. altitude the voltages $U_i$ and $U_n$ are reduced by 1.2%, nominal rating $I_n$ is reduced by 0.4% for every additional 100 m		m	2000
Mounting position			any
Resistance against vibrations			3 g (8 ... 50 Hz)
Accessories			Auxiliary contact PS50E-11 Shunt trip release VC50E Undervoltage release PC50E

6

TECHNICAL DATA

# MINIATURE CIRCUIT BREAKERS - ACCESSORIES

RI50

## AUXILIARY CONTACT BLOCK

Type	Symbol	Unit	PS 50E-11
Standards			IEC/EN 60947-5-1
Number of contacts			1 change-over *
Rated operational voltage	$U_e$	V	230
Rated insulation voltage	$U_i$	V	400
Rated frequency	f	Hz	50/60
Rated thermal current	$I_{th}$	A	6
Rated operational current	$I_e$		AC-15: 230 V / 4 A DC-13: 110 V / 0.4
Rated unconditional short-circuit current		A	800
Fuse gG		A	6
Mounting			on left side of device
Degree of protection			IP 20
Terminal capacity	S	mm <sup>2</sup>	0.5 ... 2.5 (Cu wire)
Screw type			M2.5
Screw head			PZ2
Tightening torque			1

\* Change-over contacts indicate the position of main contacts of circuit breaker

## UNDERVOLTAGE RELEASE

Type	Symbol	Unit	PC 50E
Standards			IEC/EN 60947-1
Rated voltage	$U_n$	V	230
Rated frequency	f	Hz	50
Power consumption	P	W	3
Mounting			Right side of device
Terminal capacity	S	mm <sup>2</sup>	0.75 ... 2.5
Screw type			M5
Screw head			PZ2
Tightening torque		Nm	2
Degree of protection			IP 20
Operating limits			Pick-up voltage: 85% $U_n$ Drop-out voltage: 35% $U_n$

## SHUNT RELEASE

Type	Symbol	Unit	VC 50E
Standards			IEC/EN 60947-1
Rated voltage	$U_n$	V	230 *
Rated impulse withstand voltage	$U_{imp}$	kV	4
Rated making overvoltage		kV	4
Rated frequency	f	Hz	50/60
Max. switching off current (voltage of VC)		A (V)	0.9 (125); 0.6 (230); 0.3 (400)
Mounting			on right side of circuit breaker (switch)
Degree of protection			IP 20
Terminal capacity	S	mm <sup>2</sup>	1.5 ... 6
Screw type			M5
Screw head			PZ2
Tightening torque		Nm	2.5
Operating limits			70 ... 110 % $U_n$
Tripping time		ms	max. 50

\* Other rated voltage of AC and DC on request

6

TECHNICAL DATA



# MINIATURE CIRCUIT BREAKERS - RI50

## Tripping characteristics

Characteristics B acc. to EN 60 898

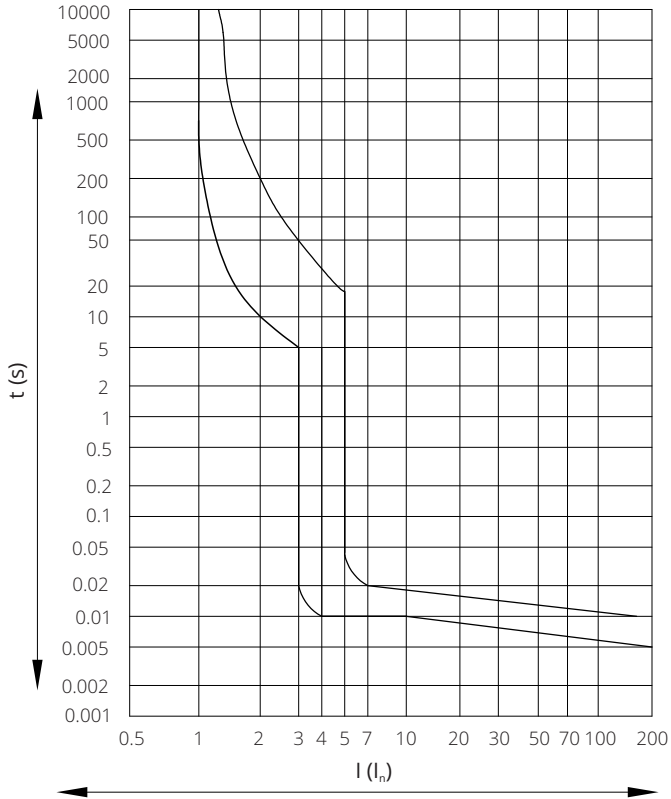

Characteristics C acc. to EN 60 898

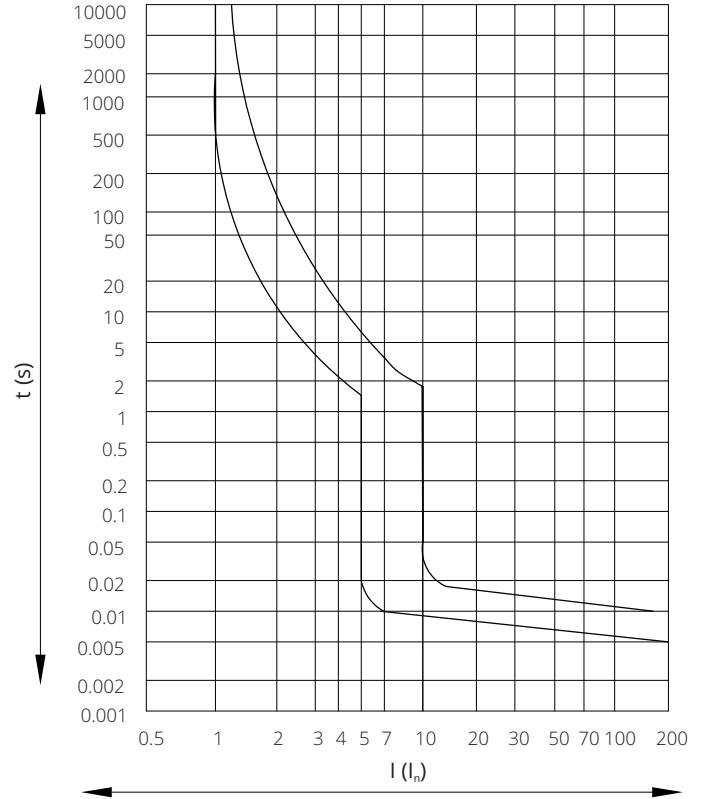

# MINIATURE CIRCUIT BREAKERS - RI50

RI51

RI52

RI52 +N  
RI53

RI53 +N  
RI54

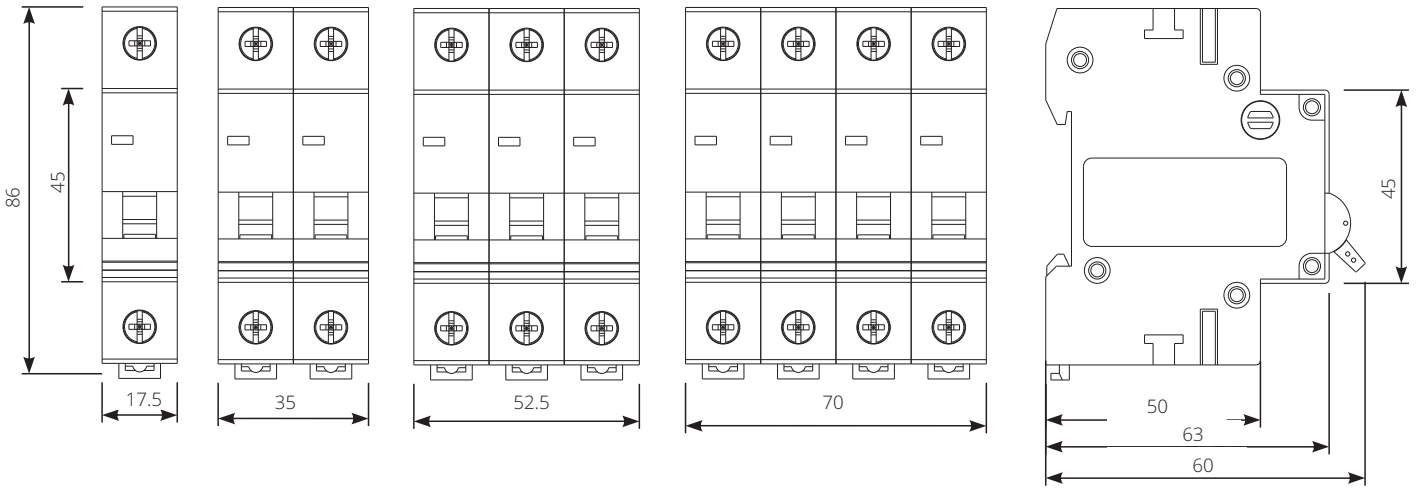

6

AUXILIARY CONTACT PS50E-11

SHUNT TRIP RELEASE VC50E

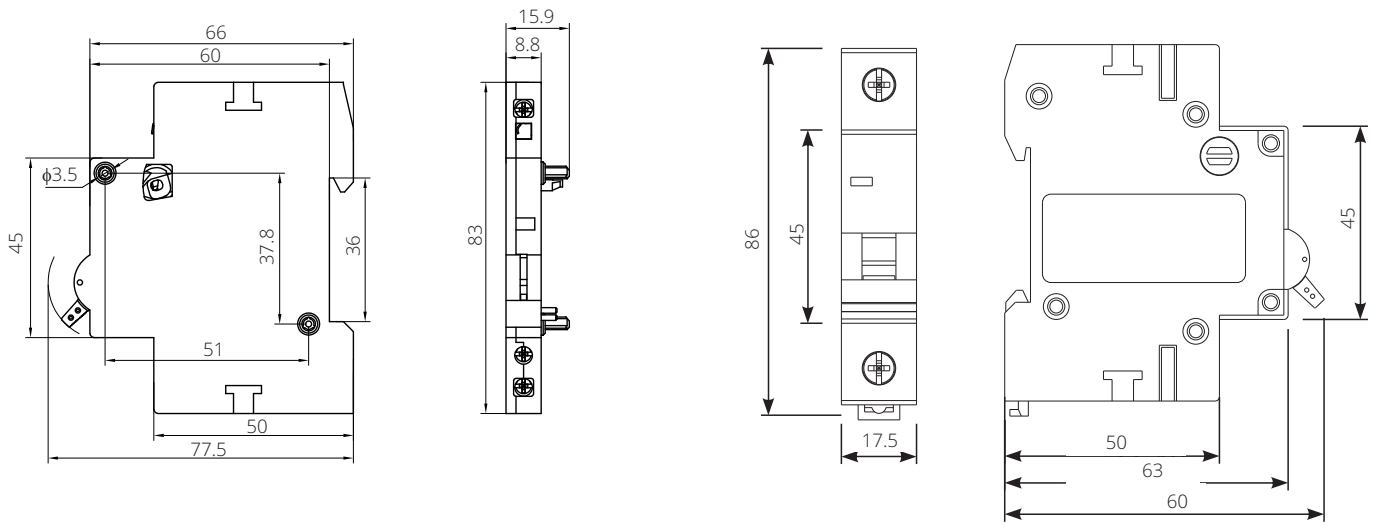

UNDERVOLTAGE RELEASE PC50E

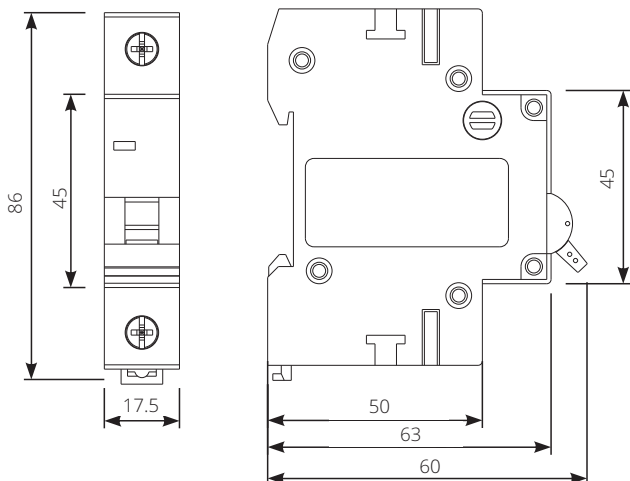

DIMENSIONS

# MINIATURE CIRCUIT BREAKERS - RI60, RI60J

Type	Symbol	Unit	RI60	RI60J
Area of use			AC systems	DC systems
Standards			IEC/EN 60898-1, IEC/EN 60947-2	
Approvals			VDE, EAC, CE	EAC, CE
Number of poles			1, 1+N, 2, 3, 3+N, 4	1, 2
Tripping characteristics			B, C, D	C
Rated currents	$I_n$	A	0.5 ... 63	
Rated voltage	$U_n$	V	230, 230/400, 400 (IEC/EN 60898-1)	220 (single-pole)
			230, 400 (IEC/EN 60947-2)	440 (two-poles) 880 (four-poles)
Rated DC voltage	$U_n$	V	max. 40 - 1-pole	220, 440, 880
Max. time constant for DC voltage	t	ms	15/60 V DC max.	3
Rated impulse withstand voltage	$U_{imp}$	kV	4	
Rated insulation voltage	$U_i$	V	500	
Rated frequency	f	Hz	50/60	-
Rated short-circuit breaking capacity	$I_{cu}, I_{cn}$	kA	10	4.5
Service short-circuit breaking capacity	$I_{cs}$	kA	7.5	4.5
Selectivity class			3	1
Electrical endurance		op.c.	6000	4000
Mechanical endurance		op.c.	100 000	
Terminal capacity		mm <sup>2</sup>	1.5 ... 25 for Cu conductors	
			2.5 ... 25 for Al conductors	
Screw type			M5	
Screw head			PZ2	
Tightening torque		Nm	2	
Mounting			35 mm DIN rail acc. to 60715, with clip on panel	
Degree of protection			IP 20	
Ambient temperature		°C	IP 40 from the front panel	
Altitude		m	-25 ... 55	
			up to 2000	
Mounting position			any	
Resistance against vibrations			3 g (8 ... 50 Hz)	
Accessories			Auxiliary and signal contacts PKJ, 2PKJ, PKJ+SKJ	
			Shunt trip release VC60	
			Undervoltage release PC60	

# MINIATURE CIRCUIT BREAKERS - RI60

Internal impedances, power losses, loop impedance and rated currents corrections

Rated current I <sub>n</sub> (A)	Internal impedance Z (mΩ)	Power losses P(W)	Max. impedance of fault loop Z(Ω)			Rated currents correction at the ambient air temperature from -20 °C to +60 °C										
			Char.B	Char.C	Char.D	-20 °C	-10 °C	0 °C	10 °C	20 °C	30 °C	40 °C	50 °C	60 °C		
	Characteristics B, C, D															
0.2			230.0	127.8	71.9	0.24	0.24	0.23	0.22	0.21	0.20	0.19	0.18	0.17		
0.3			153.3	85.2	47.9	0.36	0.35	0.34	0.33	0.32	0.30	0.28	0.26	0.25		
0.4			115.0	63.9	35.9	0.48	0.47	0.46	0.44	0.42	0.40	0.37	0.35	0.33		
0.5	6600	1.7	92.0	51.1	28.8	0.61	0.59	0.57	0.55	0.53	0.50	0.47	0.44	0.42		
0.6			76.7	42.6	24.0	0.73	0.71	0.68	0.66	0.63	0.60	0.56	0.53	0.50		
0.8		2.0	57.5	31.9	18.0	0.97	0.94	0.91	0.88	0.84	0.80	0.74	0.70	0.67		
1	1650	1.7	46.0	25.6	14.4	1.21	1.18	1.14	1.10	1.05	1.0	0.93	0.88	0.83		
1.2			38.3	21.3	12.0	1.45	1.42	1.37	1.32	1.26	1.20	1.12	1.06	1.00		
2	370	1.5	23.0	12.8	7.2	2.42	2.36	2.28	2.20	2.10	2.0	1.86	1.76	1.67		
3	210	1.9	15.3	8.5	4.8	3.63	3.54	3.42	3.30	3.15	3.0	2.79	2.64	2.50		
4	126		11.5	6.4	3.6	4.84	4.72	4.56	4.40	4.20	4.0	3.72	3.52	3.33		
4.2			11.0	6.1	3.4	5.1	5.0	4.8	4.6	4.4	4.2	3.9	3.7	3.5		
6	51	1.8	7.7	4.3	2.4	7.3	7.1	6.8	6.6	6.3	6.0	5.6	5.3	5.0		
8	21	1.3	5.8	3.2	1.8	9.7	9.4	9.1	8.8	8.4	8.0	7.4	7.0	6.7		
10	14.8	1.5	4.6	2.6	1.4	12.1	11.8	11.4	11.0	10.5	10.0	9.3	8.8	8.3		
12			3.8	2.1	1.2	14.5	14.2	13.7	13.2	12.6	12.0	11.2	10.6	10.0		
13	11.3	1.9	3.5	2.0	1.1	15.7	15.3	14.8	14.3	13.7	13.0	12.1	11.5	10.8		
14			3.3	1.8	1.0	16.9	16.5	16.0	15.4	14.7	14.0	13.0	12.3	11.7		
16	7.5	1.9	2.9	1.6	0.9	19.4	18.9	18.2	17.6	16.8	16.0	14.9	14.1	13.3		
17			2.7	1.5	0.8	20.6	20.1	19.4	18.7	17.9	17.0	15.8	15.0	14.2		
20	6.3	2.5	2.3	1.3	0.7	24.2	23.6	22.8	22.0	21.0	20.0	18.6	17.6	16.7		
21			2.2	1.2	0.7	25.4	24.8	23.9	23.1	22.1	21.0	19.5	18.5	17.5		
25	4.4	2.8	1.8	1.0	0.6	30.3	29.5	28.5	27.5	26.3	25.0	23.3	22.0	20.8		
32	3.1	3.2	1.4	0.8	0.4	38.7	37.8	36.5	35.2	33.6	32.0	29.8	28.2	26.7		
35	3.1	3.8	1.3	0.7	0.4	42.3	41.3	39.9	38.5	36.8	35.0	32.6	30.8	29.2		
40	2.5	4.0	1.2	0.6	0.4	48.4	47.2	45.6	44.0	42.0	40.0	37.2	35.2	33.8		
50	2.2	5.5	0.9	0.5	0.3	60.5	59.0	57.0	55.0	52.5	50.0	46.5	44.1	41.7		
63	1.6	6.4	0.7	0.4	0.2	76.2	74.3	71.8	69.3	66.2	63.0	58.6	55.5	52.5		

6

Selectivity of miniature circuit breakers RI60 of characteristic B with backup fuses (kA)

I <sub>n</sub> (A)	NH gG							
	20	25	32	40	50	63	80	100
≤1	0.5	1.1	5	10	10	10	10	10
2	0.5	0.9	2.5	10	10	10	10	10
4	0.5	0.8	1.3	4.8	6	10	10	10
6	0.5	0.8	1.1	2.5	3.5	5	8	10
8	0.5	0.7	1	2	2.3	3	6	10
10	0.5	0.7	0.9	1.8	2.1	2.7	5	8.5
13	0.5	0.6	0.8	1.6	2	2.6	4.2	7
16		0.6	0.8	1.5	1.9	2.5	3.8	6.5
20		0.5	0.7	1.4	1.8	2.4	3.6	6.1
25			0.7	1.3	1.8	2.3	3.4	5.8
32				1.2	1.7	2.2	3.3	5.3
40						2.1	3.2	5.1
50						2	3	4.8
63								4.5

Selectivity of miniature circuit breakers RI60 of characteristic C with backup fuses (kA)

I <sub>n</sub> (A)	NH gG							
	20	25	32	40	50	63	80	100
≤1	0.5	1.3	10	10	10	10	10	10
2	0.5	0.9	3.5	10	10	10	10	10
4	0.5	0.8	2.5	3	3.5	5	10	10
6	0.5	0.8	1	2	2.3	3	8	10
8	0.5	0.8	0.9	1.6	2	2.7	6	8.5
10		0.7	0.8	1.5	1.9	2.6	5	7
13			0.8	1.4	1.8	2.5	4.2	6.5
16				1.3	1.7	2.4	3.8	6.1
20				1.2	1.6	2.3	3.6	5.8
25					1.5	2.2	3.4	5.3
32						2.1	3.3	5.1
40						2	3.1	4.8
50								4.5
63								

TECHNICAL DATA

# MINIATURE CIRCUIT BREAKERS - RI60

Selectivity of miniature circuit breakers RI60 of characteristic D with backup fuses (kA)

$I_n$ (A)	NH gG							
	20	25	32	40	50	63	80	100
≤1	5	8	10	10	10	10	10	10
2	1.7	2	5	10	10	10	10	10
4	0.7	1.1	2	3	3.5	5.1	10	10
6	0.6	1	1.4	2	2.4	3.5	7.5	10
8	0.5	0.9	1.2	1.6	2.1	2.7	5	10
10	0.5	0.8	1	1.5	2	2.6	4.5	10
13		0.7	0.9	1.4	1.9	2.5	4.1	8
16		0.6	0.8	1.3	1.7	2.4	3.8	6.1
20			0.5	1.2	1.6	2.3	3.6	5.8
25				1.1	1.5	2.2	3.4	5.3
32					1.4	2.1	3.3	5.1
40						1.9	3.1	4.8
50							2.5	4.5
63								4

6

Tripping characteristics

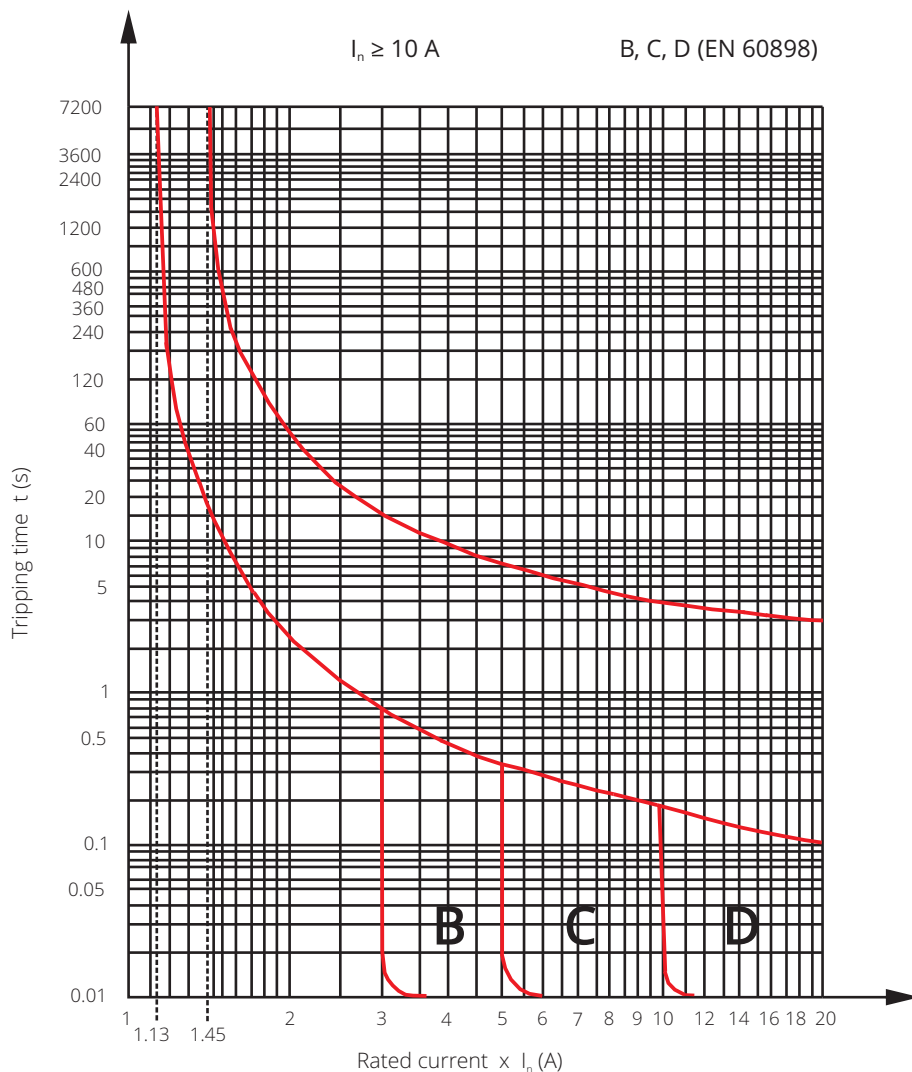

TECHNICAL DATA

# MINIATURE CIRCUIT BREAKERS - RI60, RI60J

## Correction of rated currents of miniature circuit breakers

Correction of rated currents of miniature circuit breakers installed side by side (A) Valid for reference temperature 30°C.

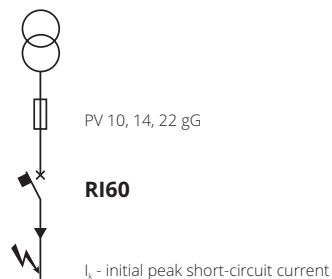
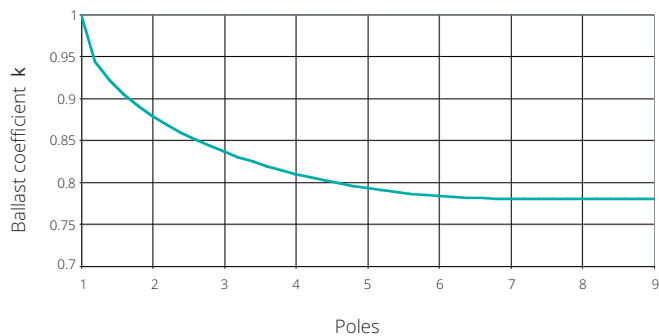

6

## RI60J

## Protection of DC circuits

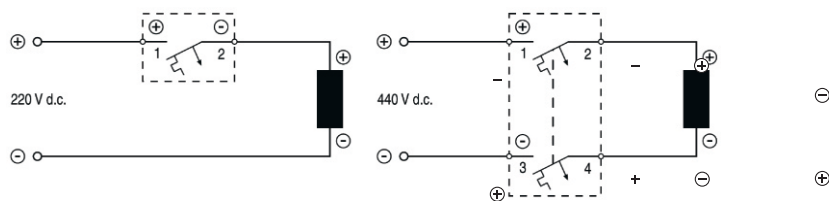

It is possible to use both RI60 and RI60J miniature circuit breakers for protection of DC circuits depending on voltage.

For voltage  $U_n$  up to:

- 40 V d.c. use miniature circuit breakers RI60. Source poles (+) and (-) can be connected to the circuit breaker terminals arbitrarily.
- 220 V d.c. or 440 V d.c., use miniature circuit breakers RI61J or RI62J. As these miniature circuit breakers are equipped with permanent magnets, source poles (+) and (-) must be connected to identically marked terminals of the circuit breakers (see connection example).

# MINIATURE CIRCUIT BREAKERS - ACCESSORIES

RI60

## AUXILIARY CONTACT BLOCK

Type	Symbol	Unit	PKJ	2PKJ	PKJ + SKJ
Standards				IEC/EN 60947-5-1	
Number of contacts			1 change-over *	2 change-over *	1 change-over 1 signal **
Rated operational voltage	$U_e$	V		230	
Rated insulation voltage	$U_i$	V		400	
Rated frequency	$f$	Hz		50/60	
Rated thermal current	$I_{th}$	A		16	
Rated operational current	$I_e$			AC-15: 230 V / 4 A DC-13: 110 V / 0.5	
Rated unconditional short-circuit current		A		800	
Fuse gG		A		16	
Mounting				on left side of device	
Degree of protection				IP 20	
Terminal capacity	S	mm <sup>2</sup>		0.5 ... 2.5 (Cu wire)	
Screw type				800	
Screw head				800	
Tightening torque				800	

\* Change-over contacts indicate the position of main contacts of circuit breaker

\*\* Signal contact indicates opening of MCB due to overload or short-circuit

## UNDERVOLTAGE RELEASE

Type	Symbol	Unit	PC 60
Standards			IEC/EN 60947-1
Rated voltage	$U_n$	V	24, 48, 120, 230, 400
Rated frequency	$f$	Hz	50
Coil power consumption	P	W	3
Mounting			Right side of device
Terminal capacity	S	mm <sup>2</sup>	0.75 ... 2.5
Screw type			M5
Screw head			PZ2
Tightening torque		Nm	2
Degree of protection			IP 20
Operating limits			Pick-up voltage: 85% $U_n$ Drop-out voltage: 35% $U_n$

## SHUNT RELEASE

Type	Symbol	Unit	VC
Standards			IEC/EN 60947-1
Rated voltage	$U_n$	V	230 *
Rated impulse withstand voltage	$U_{imp}$	kV	4
Rated making overvoltage		kV	4
Rated frequency	$f$	Hz	50
Max. switching off current (voltage of VC)		A (V)	0.6
Mounting			on right side of circuit breaker (switch)
Degree of protection			IP 20
Terminal capacity	S	mm <sup>2</sup>	1 ... 6
Screw type			M5
Screw head			PZ2
Tightening torque		Nm	2
Operating limits			70 ... 110 % $U_n$
Tripping time		ms	max. 50

\* Other rated voltage of AC and DC on request

6

TECHNICAL DATA

# MINIATURE CIRCUIT BREAKERS - RI60, RI60J

RI61  
RI61J

RI62  
RI62J

RI62 +N  
RI63

RI63 +N  
RI64

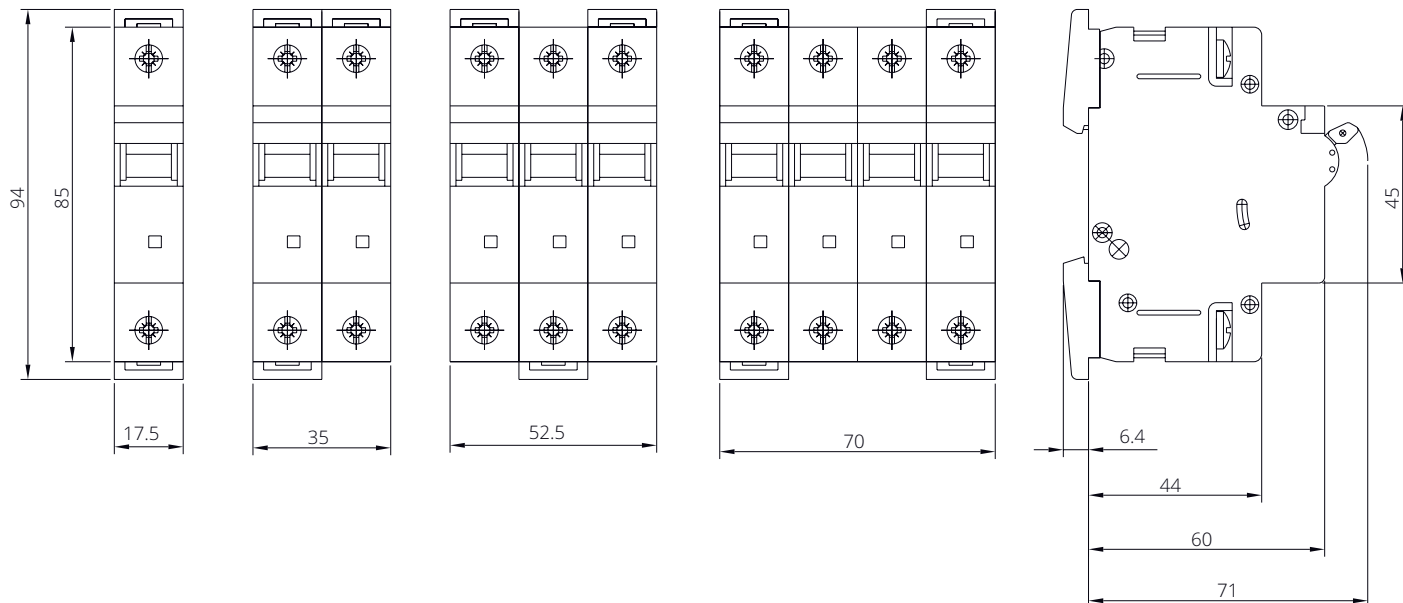

6

## SHUNT TRIP VC

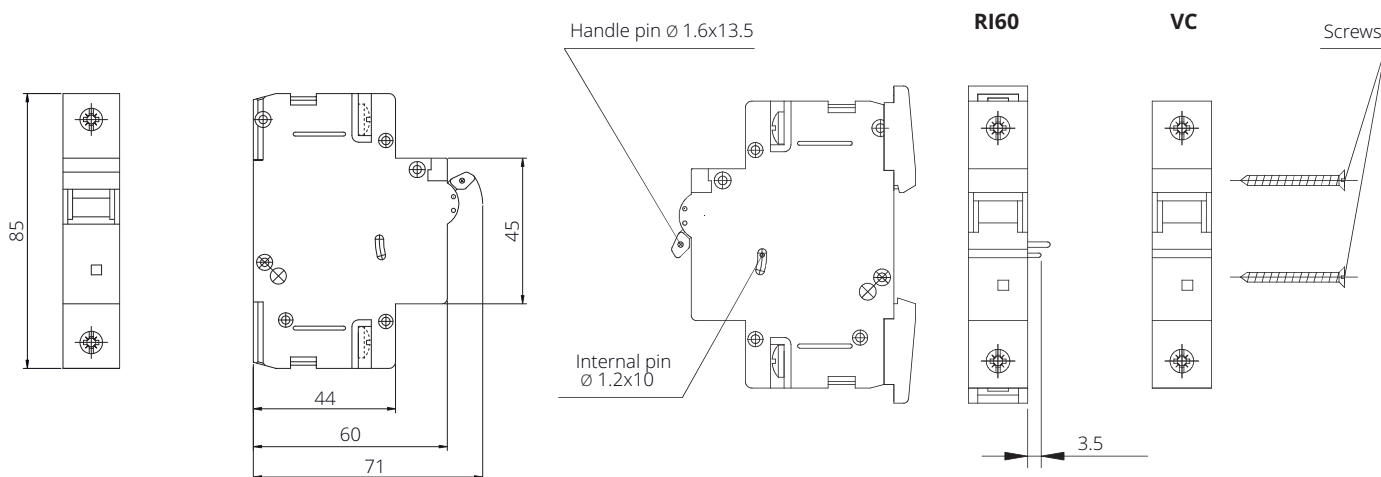

### Instructions guide for the mounting of a shunt trip VC-PR 60

- on right side of all executions RI60, RI60J, PRe 60 and modular switches RV 60
- circuit breaker and shunt trip have to be in switch-off position
- insert pin  $\varnothing 1,6$  mm into aperture of operating lever and into aperture of switching system  $\varnothing 1,2$  mm (pins are part of delivery)
- approach shunt trip to the circuit breaker in order to achieve engagement of pins into appropriate parts of circuit breaker and switching system of VC
- into free holes in shunt trip VC enter stainless steel screws and slightly tight the screws to attach it to the RI60
- check the function of VC with RI60 by switching on the the MCB and pushing the mechanism through the hole for pin  $\varnothing 1,2$  mm with appropriate tool.

DIMENSIONS



# MINIATURE CIRCUIT BREAKERS - RI60, RI60J

## UNDervOLTAGE RELEASE PC60

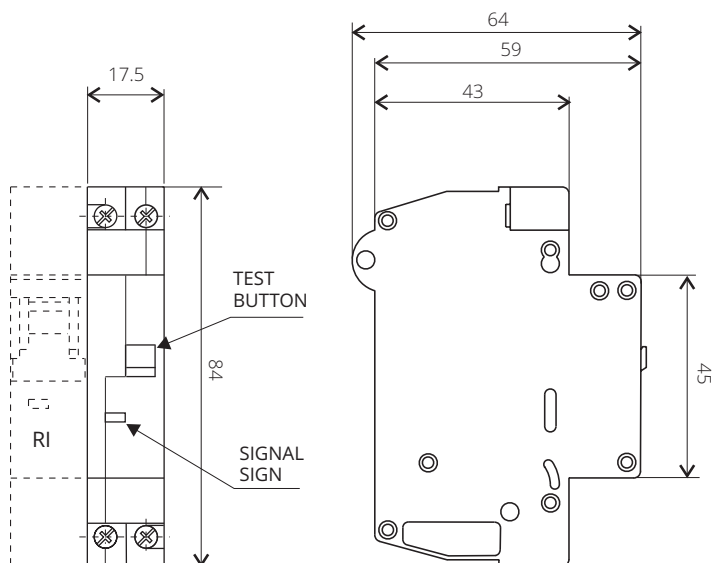

Connecting scheme

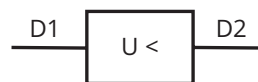

6

## SHUNT TRIP VC

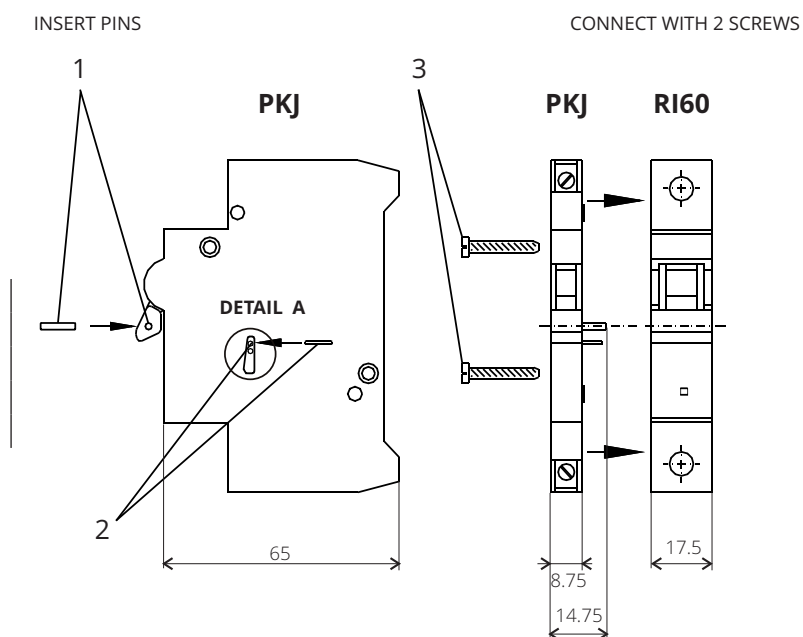

DIMENSIONS

# MINIATURE CIRCUIT BREAKERS - RI60, RI60J

## COVER OF TERMINAL KSP1

RI61, RI61J, RV 61 with single pole cover of terminals (KSP1)

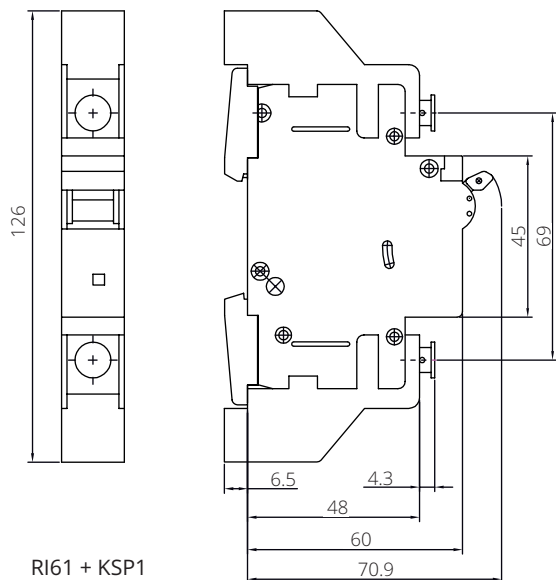

## COVER OF TERMINAL KSP3

RI63 and RV 63 with clips for mounting on board and with three pole cover of terminals (KSP3)  
Incorporating sealing blind (PZ)

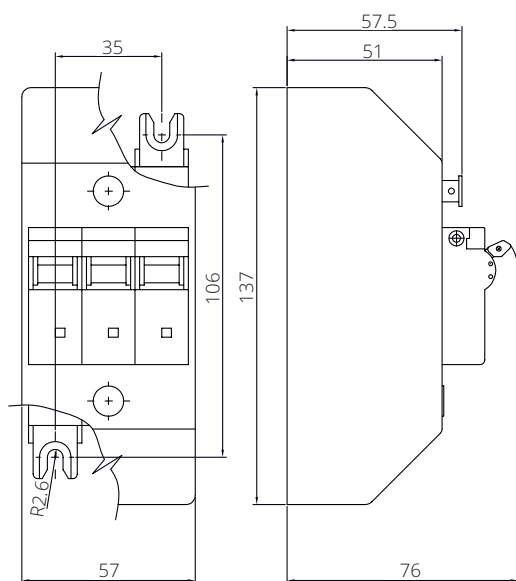

RI63 + KSP3

# MODULAR SWITCHES - RV 60 , SIGNAL LAMPS - RS

## RV60

Type	Symbol	Unit	RV60
Standards			IEC/EN 60947-3
Approvals			CE
Number of poles			1, 1+N, 2, 3, 3+N, 4
Rated insulation voltage	$U_i$	V	400
Rated impulse withstand voltage	$U_{imp}$	kV	6
Rated operational voltage	$U_e$	V	230, 400
Rated frequency	f	Hz	50 - 60
Rated thermal current	$I_{th}$	A	25, 32, 40, 63
Utilization category			AC 22A
Rated operational current	$I_e$	A	25, 32, 40, 63
With fuse gG		A	25, 35, 40, 63
Electrical endurance		op.c.	1500
Mechanical endurance		op.c.	100 000
Terminal capacity	S	mm <sup>2</sup>	1 ... 25 for Cu wires 2.5 - 25 for Al wires
Mounting			on DIN rail acc. to EN 60715; on panel
Degree of protection			IP 20, IP 40 front
Ambient temperature		°C	-25 ... +55
Mounting position			optional
Vibration resistance			3 g (8-50 Hz)
Accessories			Auxiliary and signal contacts - PKJ, 2PKJ, PKJ+SKJ Shunt release - VC 60 Undervoltage release - PC 60

6

## RS60

Type	Symbol	Unit	RS60
Standards			IEC/EN 60947-5-1
Approvals			CE
Number of poles			1
Rated voltage	$U_n$	V	AC: 24, 48, 110, 230 DC: 24, 48, 110, 220
Light source			High capacity LED diode
Light source capacity		W	0.8
Colors			transparent - T, red -R, blue - B, green - G, yellow -Y
Illumination			constant - RS
Terminal capacity	S	mm <sup>2</sup>	0.75 - 6 for Cu conductors
With fuse gG		A	25, 35, 40, 63
Electrical endurance		op.c.	1500
Mechanical endurance		op.c.	100 000
Terminal capacity			1 ... 25 for Cu wires 2.5 - 25 for Al wires
Mounting			on DIN rail acc. to EN 60715; on panel
Degree of protection			IP 20, IP 40 front
Ambient temperature		°C	-25 ... +55
Mounting position			optional

TECHNICAL DATA

# MODULAR SWITCHES - RV 60 , SIGNAL LAMPS - RS

## MODULAR SWITCHES RV

RV61

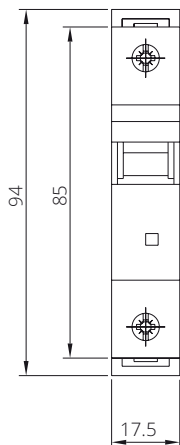

RV62

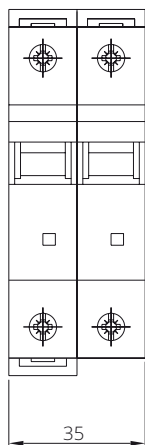

RV63

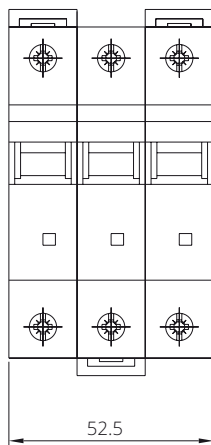

RV64

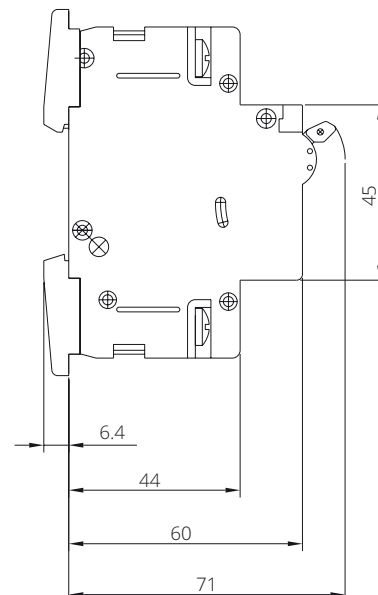
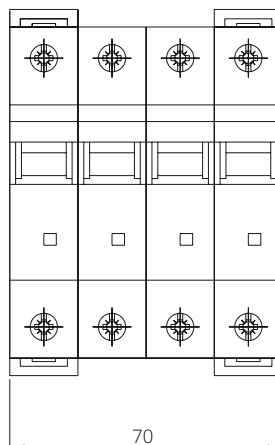

6

## SIGNAL LAMPS RS

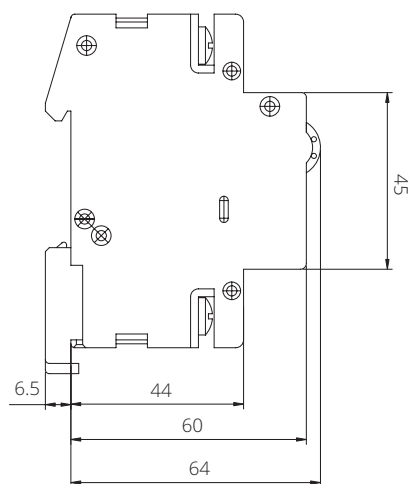
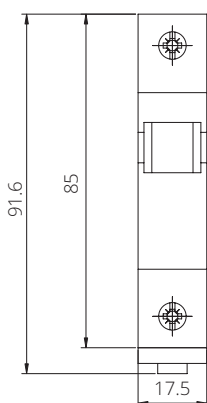

DIMENSIONS

# MINIATURE CIRCUIT BREAKERS - RI100

Type	Symbol	Unit	RI100
Area of use			AC systems
Standards			IEC/EN 60947-2
Approvals			SEMKO, CE
Number of poles			1,1+N, 2, 3, 3+N, 4
Tripping characteristics			C
Rated currents	$I_n$	A	80, 100, 125
Rated voltage	$U_n$	V	230, 230/400, 400
Rated DC voltage	$U_n$	V	max. 60
Max. time constant for DC voltage	t	ms	3
Rated impulse withstand voltage	$U_{imp}$	kV	4
Rated insulation voltage	$U_i$	V	690
Rated frequency	f	Hz	50/60
Rated short-circuit breaking capacity	$I_{cu}, I_{cs}$	kA	10
Service short-circuit breaking capacity	$I_{cs}$	kA	7.5
Selectivity class			3
Electrical endurance		op.c.	4000
Mechanical endurance		op.c.	10 000
Terminal capacity		mm <sup>2</sup>	1 ... 50
Screw type			M5
Screw head			PZ2
Tightening torque		Nm	3.5
Mounting			35 mm DIN rail acc. to 60715, with clip on panel
Degree of protection			IP 20 IP 40 from the front panel
Ambient temperature		°C	-10 ... 50
Altitude		m	up to 2000
Above max. altitude the voltages $U_i$ and $U_n$ are reduced by 1.2%, nominal rating $I_n$ is reduced by 0.4% for every additional 100 m			
Mounting position			any
Resistance against vibrations			3 g (8 ... 50 Hz)

6

TECHNICAL DATA

# MINIATURE CIRCUIT BREAKERS - RI100

## Tripping characteristics

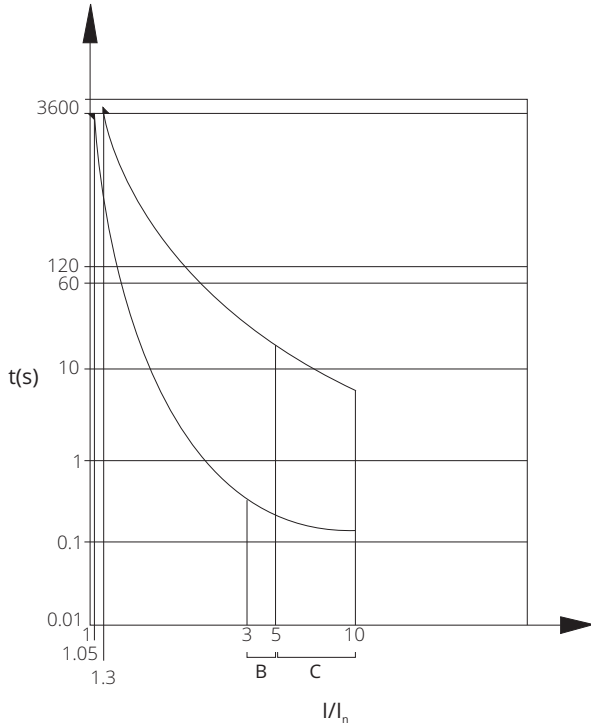

**B type**

**C type**

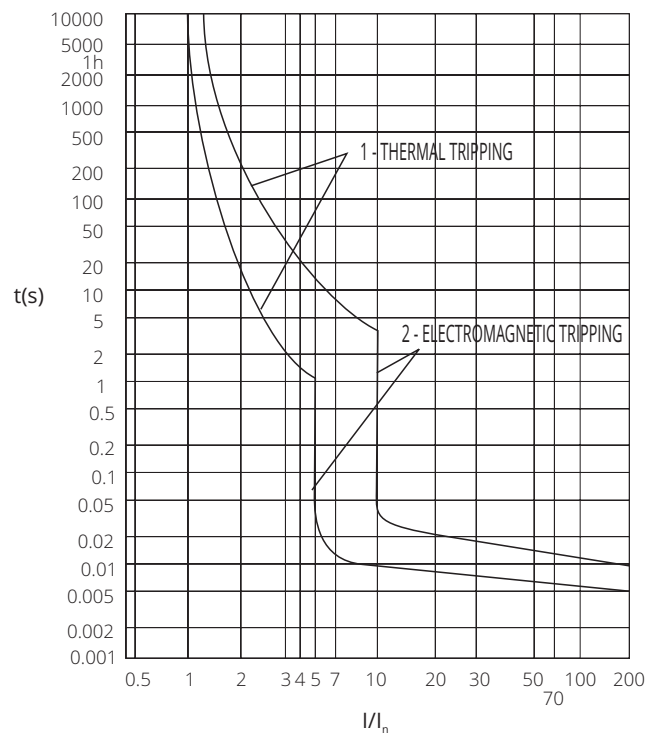
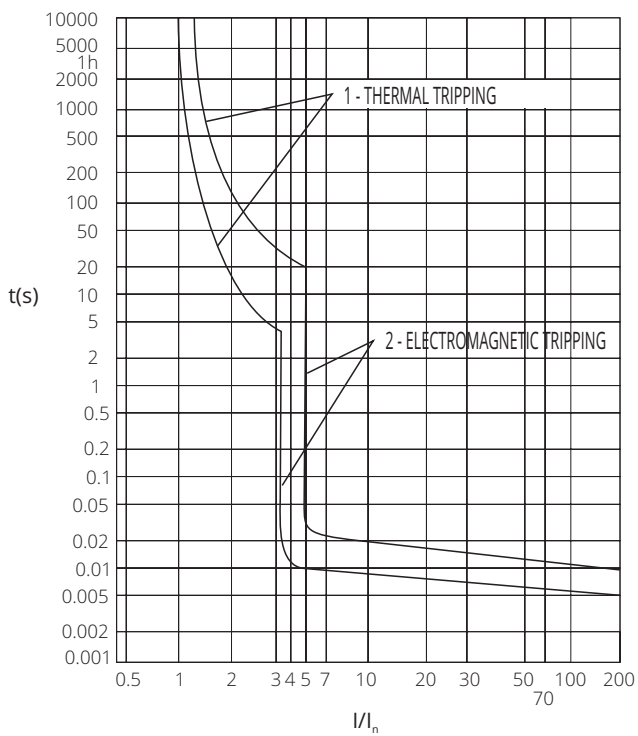

# MINIATURE CIRCUIT BREAKERS - RI100

RI101

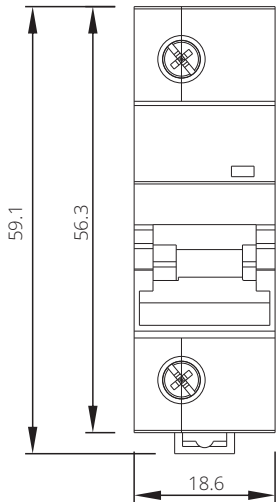

RI102  
RI102+N

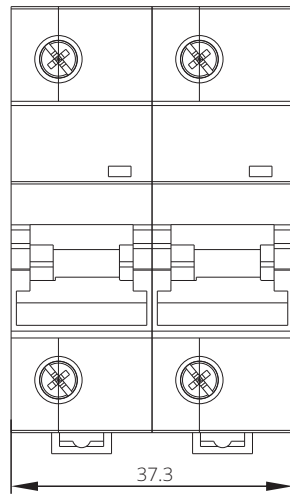

RI103

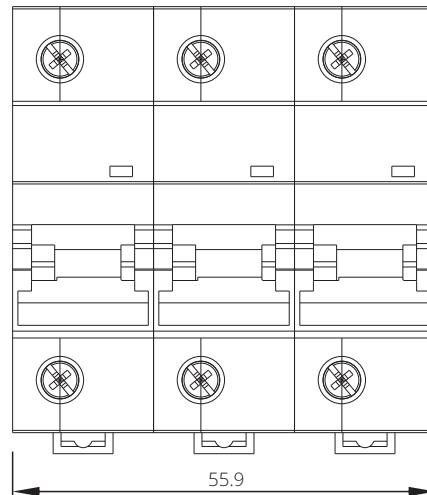

RI103 +N  
RI104

