

Universal Digital Caliper MarCal 16 EWW in set



Applications

- The 16 EWW can also be used as a standard caliper (4 types of measurement).

When used in conjunction with the standard accessories; it is possible to measure recesses, grooves, etc.

In conjunction with the additional accessories; threads, bores, serrations, etc. can be measured.

Features

Functions:

- ON/OFF
- RESET (Set display to zero)
- mm/inch
- Reference-Lock/Unlock
- DATA (Data transmission via connection cable)
- Auto-ON/OFF
- Immediate measurement due to the Reference system
- Excellent resistance against dust, coolants and lubricants, protection class IP67

- MarConnect data output, choose alternatively: USB, OPTO RS232C or Digimatic
- Dirt wipers are integrated in the slide
- Life of the battery up to 3 years
- Max measuring speed 2.5 m/s (100"/s)
- High contrast LCD with 8.5 mm high digits
- Lapped guide way

- Slide and beam made of hardened stainless steel
- Measuring blades for inside measurement
- Step measuring function
- Locking screw
- Supplied with: Case, battery, operating instructions

Technical Data

Measuring range*		Resolution	Error limit G	Order no.
mm	(inch)	mm / inch	mm/inch	
200	(8")	0.01 / .0005"	0.03/ .001"	4118807**
200	(8")	0.01 / .0005"	0.03/ .001"	4118808***

* in conjunction with accessories the measuring range may change ** includes standard accessories *** excludes standard accessories

Accessories

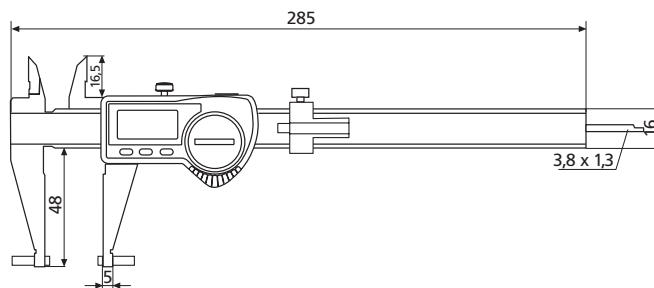

	Order no.
Battery 3V, Type CR 2032	4102520
Data Connection Cable USB (2 m)	16 EXu 4102357
Data Connection Cable Opto RS232C (2 m), with SUB-D jack 9-pin	16 EXr 4102410
Data Connection Cable Digimatic (2 m), Flat plug 10-pin	16 EXd 4102411

Accessories for Data Processing see Chapter 11

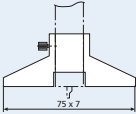
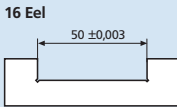
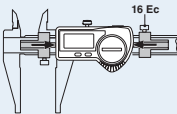
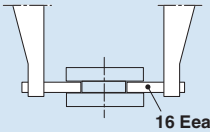
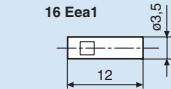
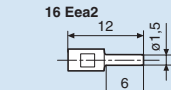
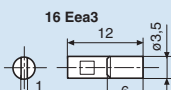
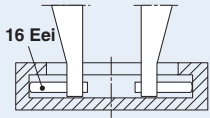

Universal Digital Caliper MarCal 16 EWW in set

Standard Accessories are included in the set

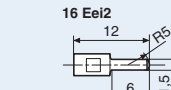
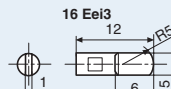
Catalog no.	Description	Order no.	Required quantity	Remarks		
16 Em	Depth Measuring Bridge	4102020	1			
16 Eel	Setting Gage for inside measurement	4118817	1			
16 Ec	Measuring Force Device	4118818	1			
16 Eea 1	Anvils for outside measurements	4118810	2			up to dia. 175 mm
16 Eea 2	Anvils for outside measurements	4118811	2			up to dia. 175 mm
16 Eea 3	Anvils for outside measurements	4118812	2			up to dia. 175 mm
16 Eei 1	Anvils for inside measurement	4118813	2			from dia. 27 mm
16 Eei 2	Anvils for inside measurement	4118814	2			from dia. 39 mm
16 Eei 3	Anvils for inside measurement	4118815	2			from dia. 39 mm
	Screws M2 x 8	4879602	2			

Additional Accessories

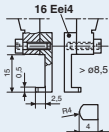
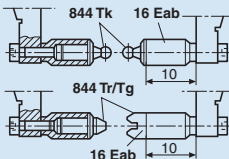
Catalog no.	Description	Order no.	Required quantity	Remarks	
16 Eei 4	Anvils for inside measurement	4118816	2		from dia. 8.5 mm
16 Eab	Mounting Attachment for 844Tg/Tr and 844 Tk	4118819	2		see Page 10-10
844 Tk	Ball Anvils		2		see Page 10-12/10-14
844 Tg/Tr	Thread Anvils		1 + 1		