

Q45AD9DLQ

Photoelectric Sensor – Diffuse Mode Sensor

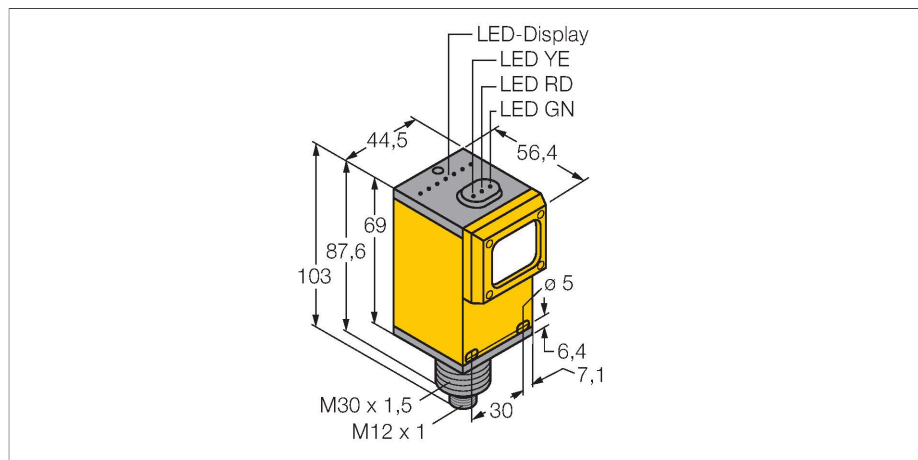

Features

- Male M12 × 1
- Protection class IP67
- Sensitivity adjusted via potentiometer
- Operating voltage: 5...15 VDC
- NAMUR output: dark ≤ 1.2 mA ; light ≥ 2.1 mA
- Acc. to EN 60947-5-6 (NAMUR)
- ATEX category II 1 G, Ex zone 0

Wiring diagram

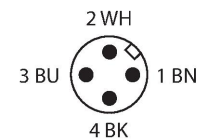
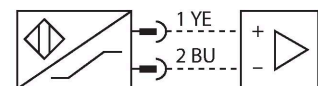

Technical data

Type	Q45AD9DLQ
ID	3037628
Optical data	
Function	Proximity switch
Operating mode	Diffuse
Light type	IR
Wavelength	880 nm
Range	0...1000 mm
Electrical data	
Operating voltage	5...15 VDC
Voltage	Nom. 8.2 VDC
Current consumption non-actuated	≤ 1 mA
Actuated current consumption	≥ 2.1 mA
No-load current	≤ 2.1 mA
Output function	Light operation, NAMUR
Switching frequency	≤ 100 Hz
Readiness delay	≤ 0 ms
Response time typical	< 5 ms
Setting option	Potentiometer
Mechanical data	
Design	Rectangular, Q45
Dimensions	$\varnothing 30 \times 103 \times 54.1 \times 44.5$ mm
Housing material	Plastic, Thermoplastic material
Lens	plastic, Acrylic
Electrical connection	Connector, M12 × 1, PVC
Number of cores	4
Ambient temperature	-40...+70 °C

Functional principle

Like retroreflective sensors, diffuse mode sensors also contain emitter and receiver circuitry in the same housing. However, diffuse mode sensors do not detect the interruption of the light beam but the reflection of the object. An object is detected if it reflects sufficient light back to the receiver. The switching distance of diffuse mode sensors thus largely depends on the object's reflectivity. This type of sensor is especially suited for detection of transparent objects (diffuse mode sensor with or without background suppression or convergent mode sensors).
 Excess gain curve
 Excess gain in relation to distance

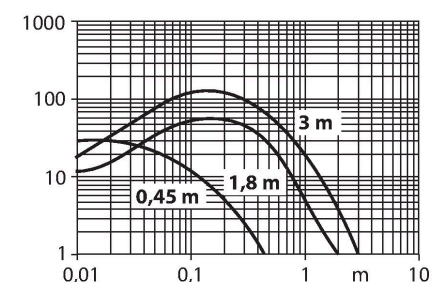

Technical data

Protection class	IP67
Switching state	LED, Red
Excess gain indication	LED, flashing
Tests/approvals	
MTTF	67 years acc. to SN 29500 (Ed. 99) 40 °C
Approvals	CE, FM, CSA
Approvals	ATEX II 1G ATEX II 2G ATEX II 3G
Device marking	Ⓔ II 1 G Ex ia IIC T5 Ga
Ignition protection category	Ex ia IIC T5
Ex approval acc. to conformity certificate	FM12ATEX0094X

Accessories

SMB30A

3032723

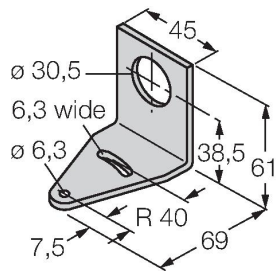

Mounting bracket, rectangular, stainless steel, for sensors with 30mm thread

SMB30FAM10

3011185

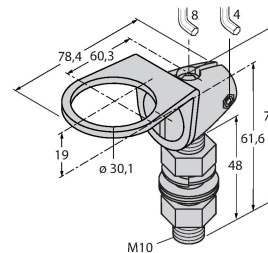

Mounting bracket, stainless steel, for M10 x 1.5 thread, thread length 30 mm

SMB30SC

3052521

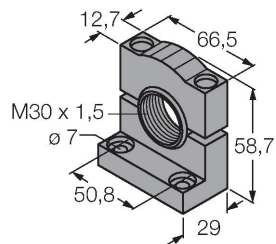

Mounting bracket, PBT black, for sensors with 30 mm thread, rotatable

Accessories

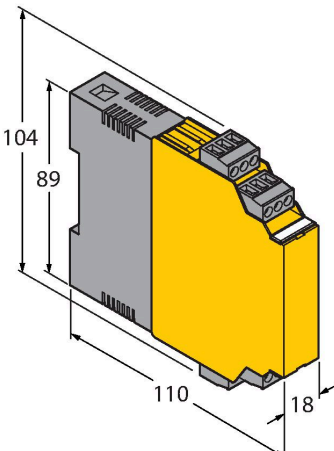
Dimension drawing	Type	ID	
	IM1-22EX-R	7541231	Isolating switching amplifier, 2-channel; 2 relay outputs; input NAMUR signal; selectable ON/OFF mode for wire-break and short-circuit monitoring; adjustable output mode (NO / NC mode); removable terminal blocks; width 18 mm; universal power supply unit

Operating Instructions

Intended use	This device fulfills the directive 94/9/EC and is suited for use in explosion hazardous areas according to EN60079-0:2009, -11:2012, -26:2007. In order to ensure correct operation to the intended purpose it is required to observe the national regulations and directives.
For use in explosion hazardous areas conform to classification	II 1 G (Group II, Category 1 G, electrical equipment for gaseous atmospheres).
Marking (see device or technical data sheet)	⊕ II 1 G and Ex ia IIC T5 Ga acc. to EN60079-0, -11 and -26
Local admissible ambient temperature	-25...+70 °C
Installation/Commissioning	<p>These devices may only be installed, connected and operated by trained and qualified staff. Qualified staff must have knowledge of protection classes, directives and regulations concerning electrical equipment designed for use in explosion hazardous areas. Please verify that the classification and the marking on the device comply with the actual application conditions.</p> <p>This device is only suited for connection to approved Exi circuits according to EN 60079-0 and EN 60079-11. Please observe the maximum admissible electrical values. After connection to other circuits the sensor may no longer be used in Exi installations. When interconnected to (associated) electrical equipment, it is required to perform the "Proof of intrinsic safety" (EN60079-14).</p>
Installation and mounting instructions	Avoid static charging of cables and plastic devices. Please only clean the device with a damp cloth. Do not install the device in a dust flow and avoid build-up of dust deposits on the device. If the devices and the cable could be subject to mechanical damage, they must be protected accordingly. They must also be shielded against strong electro-magnetic fields. The pin configuration and the electrical specifications can be taken from the device marking or the technical data sheet. In order to avoid contamination of the device, please remove possible blanking plugs of the cable glands or connectors only shortly before inserting the cable or opening the cable socket.
Service/Maintenance	Repairs are not possible. The approval expires if the device is repaired or modified by a person other than the manufacturer. The most important data from the approval are listed.